

# An Engineer's Guide



## Making Maintenance Matter

Optimising plant availability using  
laser shaft alignment, vibration analysis  
and dynamic balancing techniques



PRÜFTECHNIK



Machinery Service

**Ask for the professionals**

PRÜFTECHNIK  
Condition Monitoring  
Oskar-Maesster-Str. 19-21  
85737 Ismaning, Germany  
www.pruftechnik.com  
Tel: +49 89 99616-0  
Fax: +49 89 99616-300  
eMail: info@pruftechnik.com



**Laser shaft alignment**  
(horizontal, vertical, machine trains)

▶ Take advantage of  
our indispensable  
**Measurement Systems**  
or benefit from the  
extensive experience  
of our global  
**Machinery Service!** ◀



**Turbine alignment**



**Machine park online + offline  
condition monitoring**



**Roller alignment**



**Mobile measurement,  
Diagnostic + troubleshooting service**



**Geometric alignment**  
(surface profile, bearing shells, bores)

An  
**Engineers Guide**  
to  
**Shaft Alignment  
Vibration Analysis  
Dynamic Balancing**

Care has been taken by the authors, PRUFTECHNIK LTD, in the preparation of this publication. It is not intended as a comprehensive guide to alignment, analysis or balancing of process machinery, nor is it a substitute for seeking professional advice or reference to the manufacturers of the machinery. No liability whatsoever can be accepted by PRUFTECHNIK LTD, PRUFTECHNIK AG or its subsidiaries for actions taken based on information contained in this publication. PRUFTECHNIK AG and/or its subsidiaries assume no responsibility directly or indirectly for any claims from third parties resulting from use or application of information contained in this handbook.

Edition 7; 04.2010  
©2002 PRUFTECHNIK LTD.  
All rights reserved.

PRUFTECHNIK  
Condition Monitoring  
Oskar-Messter-Str. 19-21  
85737 Ismaning, Germany  
Tel: +49 89 99616-0  
Fax: +49 89 99616-300  
eMail: [info@pruftechnik.com](mailto:info@pruftechnik.com)  
[www.pruftechnik.com](http://www.pruftechnik.com)

A member of the PRUFTECHNIK group

# Introduction

---

The purpose of producing this handbook is to provide basic information and guidelines for the implementation of good shaft alignment, vibration analysis and dynamic balancing practice for standard rotating machines systems.

Laser alignment, dynamic balancing and condition monitoring are essential components of a viable maintenance strategy for rotating machines. In isolation each strategy helps to reduce unexpected machine failure but taken together they form the hub of a proactive maintenance strategy that will not only identify incipient problems but will extend machine operating life considerably.

In each section of this handbook we have used one or two examples of the available methods for measuring the required parameters. We do not suggest that the methods illustrated are the only ones available. For anyone wishing to pursue further the subjects covered here a bibliography of some of the available literature is to be found at the end of this handbook.

Pruftechnik are specialists in the alignment and monitoring of rotating machines, we have accumulated substantial practical knowledge of these subjects over the 30 years of our existence, in so doing we have produced many handbooks covering individual subjects and systems. This handbook is a distillation of this accumulated knowledge plus a brief overview in each section of the latest systems from Pruftechnik that address the specific applications concerned.

We hope that this information is presented in a clear readable form and that it will provide for the reader new to the subject a platform to successfully apply profitable maintenance practice on their plant.

We are indebted to our colleagues in Pruftechnik AG (Germany) and our associates at Ludeca Inc. USA for permission to reproduce some of the graphics used in this handbook, additionally we have drawn on information previously published in Pruftechnik equipment handbooks for information on alignment standards, and graphical and mathematical methods of balance calculation. For this information we are grateful.

## Section 1 Shaft Alignment

	Page Number
What is shaft alignment	9
.. A definition	9
.. Machine catenary	10
.. Operation above critical speed	11
Expressing alignment	13
.. Alignment parameters	13
.. Angularity, gap and offset	14
.. Short flexible couplings	17
.. Spacer shafts	18
How precise should alignment be?	21
.. Alignment tolerances	21
Trouble shooting	24
.. Coupling strain and shaft deflection	24
Causes of machine breakdown	26
.. Couplings and misalignment	26
.. Bearings	27
.. Seal wear	27
.. Machine vibration	27
.. Symptoms of misalignment	28
Alignment methods and practice	30
.. Machine installation guidelines	31
.. Measurement and correction of soft foot	32
Alignment by Eyesight	32

# Contents

---

	Page Number
Alignment by Dial indicator	39
.. Trial and error method	40
.. Rim and face method - by calculation	41
.. Reverse indicator method - by calculation	44
.. Reverse indicator method - by graph	47
.. Indicator bracket sag measurement	50
Alignment by Laser	51
.. Basic operation requirements	55
Laser alignment case study	
.. Laser alignment cuts energy costs	59
.. Laser alignment improves pump reliability	63
.. Laser alignment improves bearing & seal life	65
.. Laser alignment reduces vibration alarms	66
Thermal expansion of machines	67
.. Thermal growth calculations	68
Rotalign Ultra laser alignment system	70

## **Pulley and Sheave Alignment**

Alignment of pulleys and Sheaves	74
Belt Tension measurement	76
Pulley Alignment - types of misalignment	77
Pulley Run-Out checks	78
Drive Belt fitting	79
Pulley Alignment tolerances	80
Pulley Alignment by laser	81

	Page Number
<b>Section 2 Vibration analysis</b>	
Condition monitoring	88
.. The nuts and bolts of a CM system	79
.. Implementing a CM program	90
.. Return on a CM investment	91
.. Why vibration analysis?	93
Vibration analysis - Basic parameters	94
Vibration analysis - Transducers	102
Vibration analysis - Fault detection	107
.. Fault mode analysis	109
.. Unbalance	111
.. Misalignment	111
.. Loosness	112
.. Bearing problems	112
.. Aerodynamic and hydraulic problems	113
.. Gearbox problems	113
Vibration analysis - Bearings - Enveloping	114
Vibration analysis - Bearings - shock pulse analysis	118
Vibration analysis - A common sense approach	123
Vibscanner data collector and analyser	125

	Page Number
<b>Section 3 Dynamic balancing</b>	
Balancing standards	131
Balancing correction methods	136
.. Single plane three point balancing	138
.. Single plane stroboscopic method	142
.. Single plane stroboscopic method (gaphical)	143
.. Single plane stroboscopic method (calculation)	144
.. Two plane stroboscopic method (calculation)	147
Trial weight calculation	152
Balancing safety	153
VIBSCANNER Balancing system	154
About Pruftechnik	158
Glossary of Pruftechnik products	162
Bibliography	171



# OPTALIGN<sup>®</sup> smart

Laser shaft alignment with wireless  
Bluetooth<sup>®</sup> sensor communication



Aligns horizontal machines



Prints reports to any printer



Aligns vertical machines



Easy to understand graphics



Overcomes shaft rotation restrictions



In built alignment tolerances



Aligns machine trains



Modular design for easy system purchase

---

# Section 1

# Shaft

# Alignment

# What is shaft alignment?

---

## **A Definition.**

Shaft alignment is the process whereby two or more machines (typically a motor and pump) are positioned such that at the point of power transfer from one shaft to another, the axes of rotation of both shafts should be colinear when the machine is running under normal conditions.

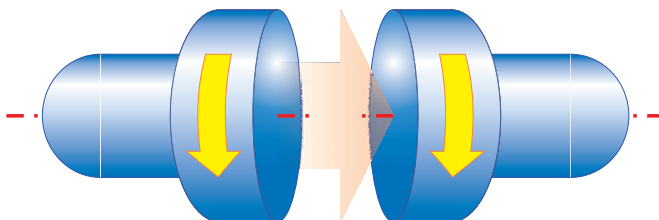

As with all standard definitions there are exceptions. Some coupling types, for example gear couplings or cardan shafts, require a defined misalignment to ensure correct lubrication when operating,

The important points to note in the above definition are.

### **At the point of power transfer...**

All shafts have some form of catenary due to their own weight, thus shafts are not straight, therefore the location where the alignment of the two shafts can be compared is only at the point of power transfer from one shaft to the next.

### **...the axes of rotation...**

Do not confuse “shaft alignment” with “coupling alignment”. The coupling surfaces should not be used to measure alignment condition since they do not represent the rotation axis of the shafts. To save manufacturing costs coupling surfaces are often only rough machined or in some cases not machined at all.

# What is shaft alignment?

---

**The accuracy of the fit of the coupling on the shaft is unknown.**

Rotating only one shaft and using dial gauges to measure the opposing coupling surface does not determine the axis of rotation of both shafts.

**... under normal operating conditions.**

The alignment condition can change when the machine is running. This can be for a number of reasons including thermal growth, piping strain, machine torque, foundation movement and bearing play. Since shaft alignment is usually measured with the machines cold, the alignment condition as measured is not necessarily the zero alignment condition of the machines. (see page 67 - 69)

Alignment condition should be measured whilst turning the shafts in the normal direction of rotation. Most pumps, fans and motors etc. have arrows on the end casing showing direction of rotation.

## Machinery catenary

The amount of shaft deflection in a machine depends upon several factors such as the stiffness of the shafts, the amount of weight between overhanging supports, the bearing design and the distance between the supports.

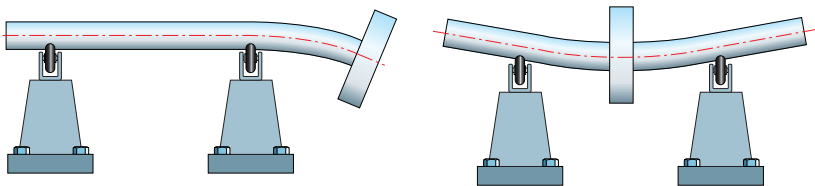

*The natural bending of shafts under their own weight*

# What is shaft alignment?

For the vast majority of close coupled rotating machines this catenary bow is negligible, and therefore for practical purposes can be ignored. On long drive machine trains, e.g. turbine generators in power generation plants or machines with long spacer shafts e.g. cooling tower fans or gas turbines, the catenary curve must be taken into consideration.

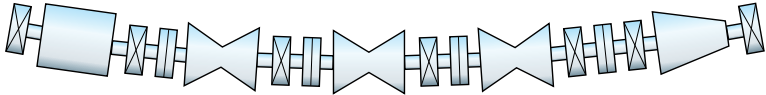

*Machine catenary*

In a steam turbine for example the shafts are usually aligned to each other better than 1/100th mm, but the mid point of the centre shaft could be as much as 30 mm lower than the two end shafts.

## Operation above critical speed?

When a very long, flexible shaft begins to rotate, the bow of the shaft tries to straighten out, but will never become a perfectly straight line. It is important to understand that the axis of rotation of a shaft could very possibly run on a curved axis of rotation. In situations where two or more pieces of machinery are coupled together with one or more shaft rotating around a catenary shaped axis of rotation, it is important to align the shafts so that they maintain the curved centre-line of rotation.

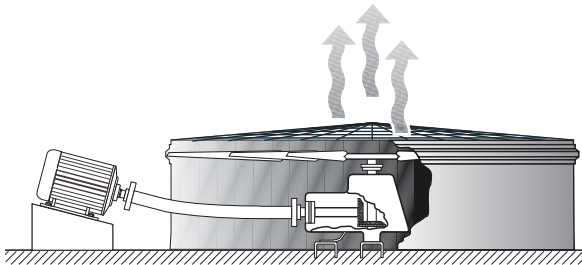

*Drive shaft operation below critical speed:  
Align machine couplings to spacer couplings*

## What is shaft alignment?

---

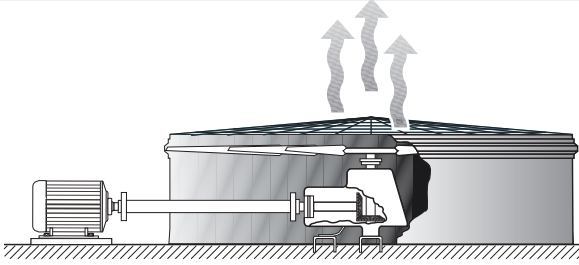

*Drive shaft operation above critical speed:  
Align machine couplings to one another ignoring spacer.*

# Expressing alignment

---

## Alignment parameters

Since shaft alignment needs to be measured and subsequently corrected, a method of quantifying and describing alignment condition is necessary.

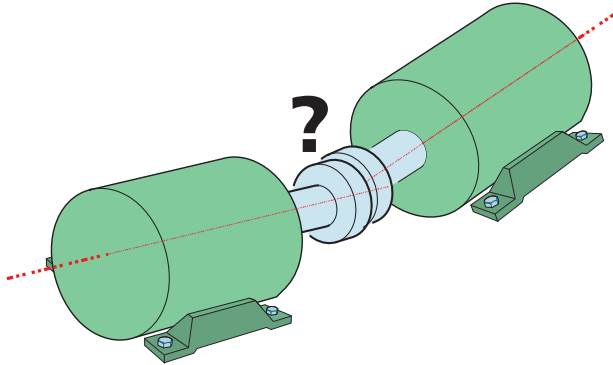

Traditionally alignment has been described in terms of dial indicator readings at the coupling face or position values at the machine feet. The measured values from both of these methods are dependant upon the dimensions of the machines. Since there are many different methods for mounting dial indicators (reverse indicator, rim and face, double rim for example) the comparison of measurements and the application of tolerances can be problematic. Additionally the fact that rim indicator readings show twice the true offset and sign reversals must be observed depending on whether the indicator measures an internal or external, left or right coupling face or rim.

A more modern and easily understandable approach is to describe machine alignment condition in terms of **angularity** and **offset** in the horizontal (plan view) and vertical (side view). Using this method four values can then be used to express alignment condition as shown in the following diagram.

# Expressing alignment

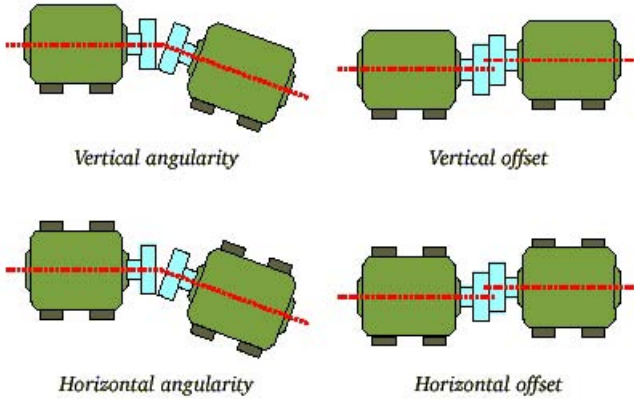

## Angularity, gap and offset

**Angularity** describes the angle between two rotating axes.

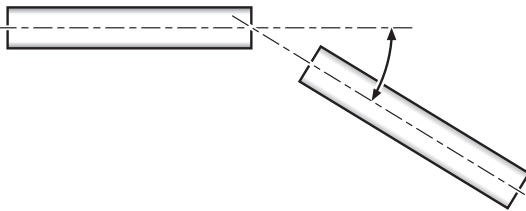

Angularity can be expressed directly as an angle in degrees or mrads, or in terms of a slope in mm/m or thous/inch. This latter method is useful since the angularity multiplied by the coupling diameter gives an equivalent gap difference at the coupling rim.

Thus the angle is more popularly expressed in terms of GAP per diameter. The gap itself is not meaningful, it must be divided by the diameter to have meaning. The diameter is correctly referred to as a “working diameter”, but is often called a coupling diameter. The working diameter can be any convenient value. It is the relationship between gap and diameter that is important.



# Expressing alignment

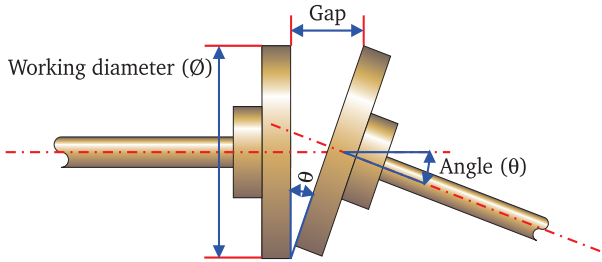

*Relationship of angle, gap and working diameter.*

A 6 inch (152.4mm) coupling open at the top by 0.005 inches (0.127mm) gives an angle between shafts axes of 0.83 mrad.

For a 10 inch working diameter this corresponds to a gap of 0.0083 inches.

For a 100 mm working diameter this corresponds to a gap of 0.083 mm.

Note: 1 mrad = 1 thousandths of an inch per inch  
1 mrad = 1mm per meter

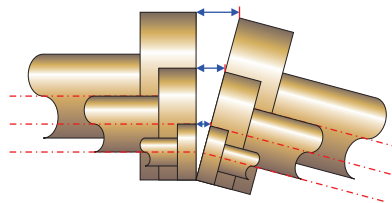

*same angle - different gap*

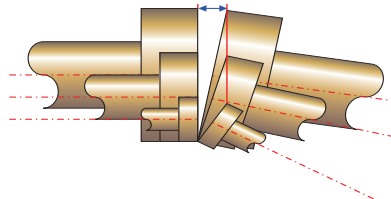

*same gap - different angle*

## Expressing alignment

**Offset** describes the distance between rotation axes at a given point. Offset is sometimes incorrectly referred to as parallel offset or rim misalignment, the shaft rotation axes are however rarely parallel and the coupling or shaft rim has an unknown relationship to the shaft rotation axes.

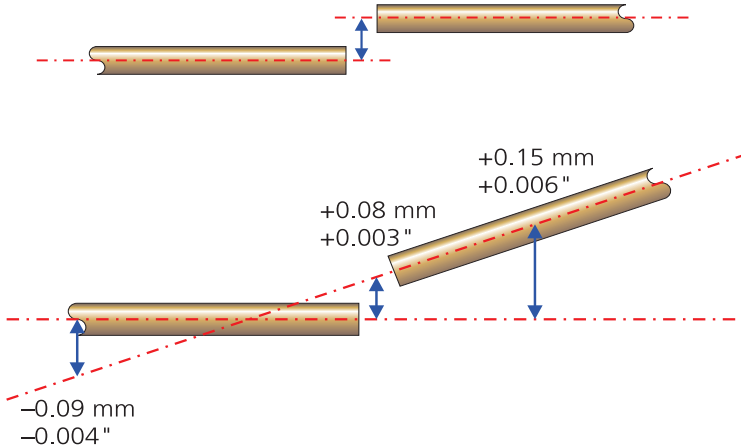

As shown above, for the same alignment condition, the offset value varies depending upon the location where the distance between two shaft rotation axes is measured. In the absence of any other instruction, offset is measured in mm or thousandths of an inch at the coupling centre. (This definition refers to short flexible couplings, for spacer couplings offset should be measured at the power transmission planes of the coupling).

# Expressing alignment

## Short Flexible couplings

For ease of understanding we define short flexible couplings when **the axial length of the flexible element or the axial length between the flexible element is equal or smaller than the coupling diameter.**

Machines with short flexible couplings running at medium to high speed require very accurate alignment to avoid undue loading of the shafts, bearings and seals.

Since the alignment condition is virtually always a combination of angularity and offset, and the machine has to be corrected in both vertical and horizontal planes, 4 values are required to fully describe the alignment condition.

Vertical angularity (or gap per diameter)

Vertical offset

Horizontal angularity (or gap per diameter)

Horizontal offset.

Unless otherwise specified the offset refers to the distance between shaft rotation axes at the coupling centre.

The sketch below shows the notation and sign convention.

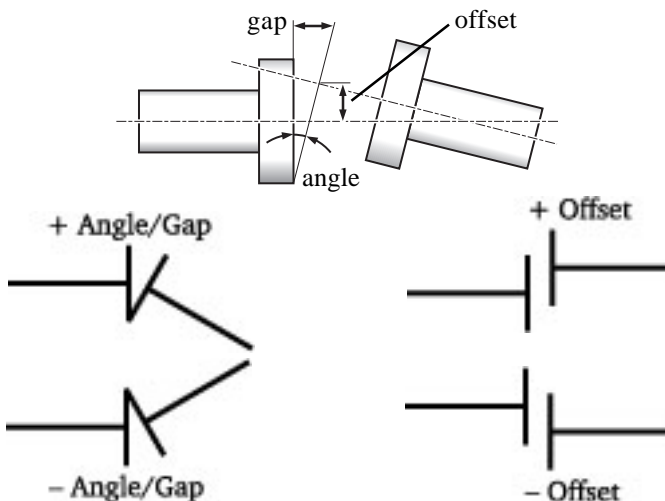

# Expressing alignment

## Spacer Shafts.

Spacer shafts are usually installed when significant alignment changes are anticipated during operation of the machine, for example due to thermal growth. Through the length of the spacer shaft, the angular change at the spacer shaft end remains small even when larger machine positional changes occur. The alignment precision for machines fitted with spacer shafts that have flexible elements at each end is not as critical as for machines that have short flexible couplings installed.

Four values are required to fully describe the alignment condition.

Vertical angle  $\alpha$

Vertical angle  $\beta$

Horizontal angle  $\alpha$

Horizontal angle  $\beta$

Angles are measured between the spacer shaft rotation axis and the respective machine rotation axes.

The sketch below shows notation and sign convention

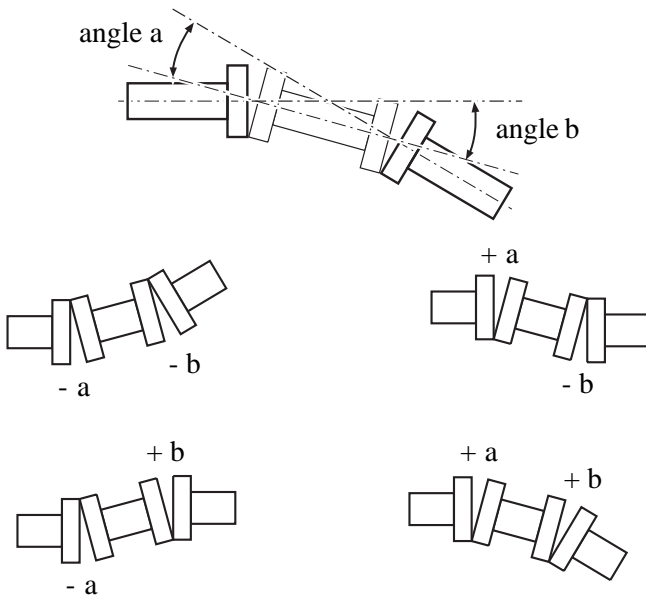

# Expressing alignment

## Offset B - offset A

As an alternative to the 2 angles  $\alpha$  and  $\beta$  the alignment can be specified in terms of offsets.

Vertical offset B

Vertical offset A

Horizontal offset B

horizontal offset A

The offsets are measured between the machine shaft rotation axes at the location of the spacer shafts ends. This is similar to reverse indicator alignment.

The sketch shows the notation and sign convention.

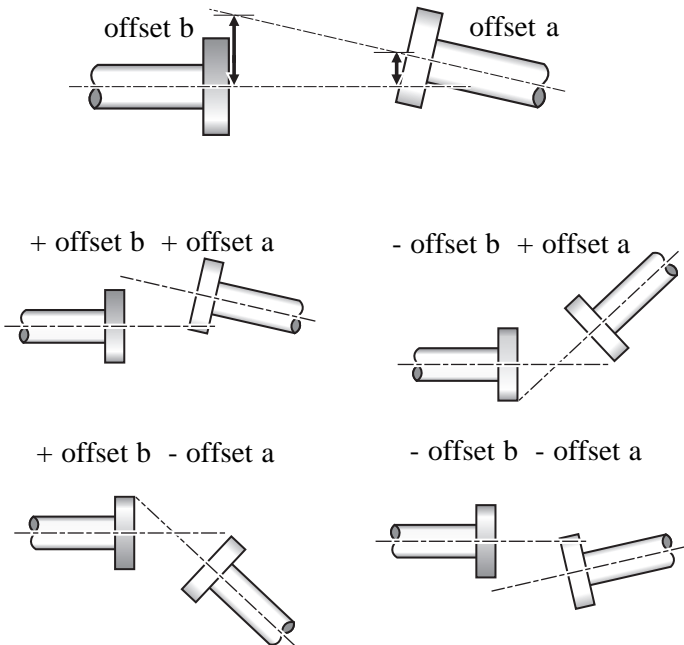

# Expressing alignment

---

## Relationships.

By studying the diagram below a clearer understanding of the relationship between the various offsets and angles will be obtained.

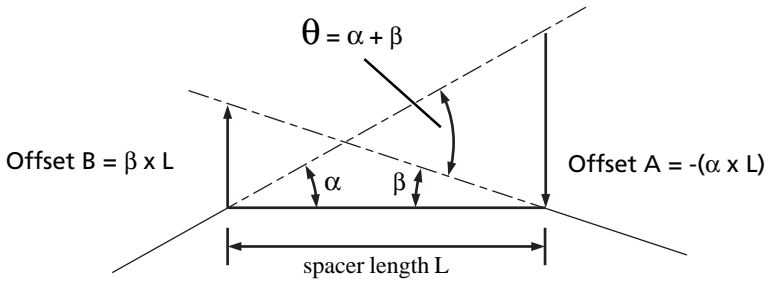

## **How precise should alignment be?**

---

### **Alignment tolerances for flexible couplings.**

The suggested tolerances shown on the following pages are general values based upon over 20 years of shaft alignment experience at PRUFTECHNIK and should not be exceeded. They should be used only if no other tolerances are prescribed by existing in-house standards or by the machine manufacturer.

Consider all values to be the maximum allowable deviation from the alignment target, be it zero or some desired value to compensate for thermal growth. In most cases a quick glance at the table will tell whether coupling misalignment is allowable or not.

As an example, a machine with a short flexible coupling running at 1500RPM has coupling offsets of -0.04 mm vertically and +0.02 mm horizontally, both of these values fall within the “excellent” limit of 0.06 mm.

Angularity is usually measured in terms of gap difference. For a given amount of angularity, the larger the diameter the wider the gap at the coupling rim (see page 15). The following table lists values for coupling diameters of 100 mm or 10 inches. For other coupling diameters multiply the value from the table by the appropriate factor. For example, a machine running at 1500 RPM has a coupling diameter of 75 mm. At this diameter the maximum allowable gap would be;  $0.07 \text{ mm} \times 75/100 = 0.0525 \text{ mm}$ .

For spacer shafts the table gives the maximum allowable offset for either 100 mm or 1 inch of spacer shaft length. For example, a machine running at 6000 RPM with 300 mm of spacer shaft length would allow a maximum offset of;  $0.03 \text{ mm} \times 300/100 = 0.09 \text{ mm}$  at either coupling at the ends of the spacer shaft.

Rigid couplings have no tolerance for misalignment, they should be aligned as accurately as possible.

# How precise should alignment be?

## Suggested alignment tolerance table.

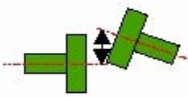
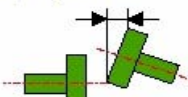
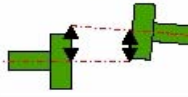
	RPM	metric (mm)		Inch (mils)	
		Acceptable	Excellent	Acceptable	Excellent
<b>Short "flexible" couplings</b> <b>Offset:</b> 	600			9.0	5.0
	750	0.19	0.09		
	900			6.0	3.0
	1200			4.0	2.5
	1500	0.39	0.06		
	1800			3.0	2.0
	3000	0.36	0.03		
	3600			1.5	1.0
	6000	0.33	0.02		
	7200			1.0	0.5
<b>Angularity</b> Metric values—Gap difference per 100 mm coupling diameter Inch values—Gap difference per 10 inch coupling diameter 	600			15.0	10.0
	750	0.13	0.09		
	900			10.0	7.0
	1200			8.0	5.0
	1500	0.37	0.05		
	1800			5.0	3.0
	3000	0.34	0.03		
	3600			3.0	2.0
	6000	0.33	0.02		
	7200			2.0	1.0
<b>Spacer shafts and membrane (disc) couplings</b> Metrics values—Offset per 100 mm spacer shaft Inch values—Offset per inch spacer length 	600			3.0	1.8
	750	0.25	0.15		
	900			2.0	1.2
	1200			1.5	0.9
	1500	0.12	0.07		
	1800			1.0	0.6
	3000	0.07	0.04		
	3600			0.5	0.3
	6000	0.03	0.02		
	7200			0.3	0.2
<b>Soft-foot</b>	Any		0.06		2



## **How precise should alignment be?**

---

### **Note**

For industrial equipment the amount of misalignment that can be tolerated is a function of many variables including RPM, power rating, coupling type, spacer length, design of coupled equipment and expectations of the user with respect to service life. Since it is not practical to consider all these variables in a reasonably useful alignment specification, some simplification of tolerances is necessary.

Tolerances based on RPM and coupling spacer length were first published in the 1970's. Many of the tolerances were based primarily on experience with lubricated gear type couplings. Experience has shown however that these tolerances are equally applicable to the vast majority of non lubricated coupling systems that employ flexible elements in their design.

In the previous table "acceptable" limits are calculated from the sliding velocity of lubricated steel on steel, using a value of 12 mm/sec for allowable sliding velocity. Since these values also coincide with those derived from elastomer shear rates they can be applied to short flexible couplings with flexible elements.

"Excellent" values are based on observation made on a wide variety of machines to determine critical misalignment for vibration. Compliance with these tolerances does not however guarantee vibration free operation.

## Coupling strain and shaft deflection

### New readings do not agree with moves just made?

When performing an alignment whether using dial indicators or laser optical systems, sometimes the readings following an alignment adjustment does not agree with the corrections made. One possibility is that coupling strain is bending the shaft, the machine mounts or the foundation. This has frequently been noticed particularly on pump sets which have a front “steady” mount as shown in the following sketch.

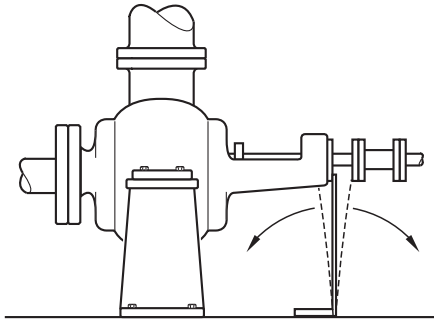

In this application the flexible coupling element is radially quite rigid and can influence the alignment measurement. In this situation we advise splitting the coupling element to free the measured alignment from such external forces.

If not accommodated the net effect of influences such as noted above is that the new alignment is not only wrong but quite often has been made in the opposite direction to the required alignment correction.

In extreme cases coupling strain imposed by the newly aligned machines can bend shafts during operation. In most cases this bending will be minimal but sufficient to effect the measured axes of shaft rotation. The following sketches illustrate the potential problem

# Trouble shooting

---

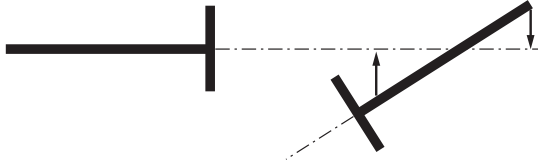

This is the alignment condition with shafts uncoupled

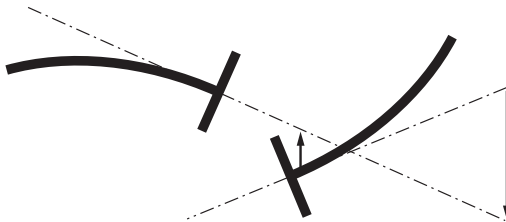

This is the measured alignment with the shafts coupled.  
Projected centrelines of rotation are shown

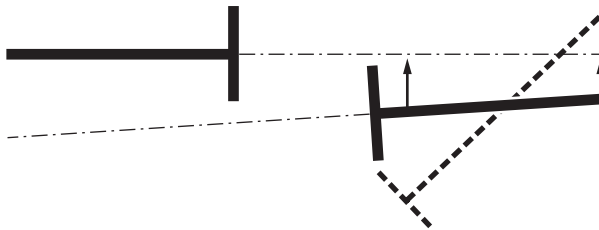

The moves are made as measured. There is less strain on the coupling now and the shafts will be properly aligned at the next attempt

# Causes of machine breakdown

---

## Couplings can take misalignment?

An often quoted comment is “...why bother to align the machine when it is fitted with a flexible coupling designed to take misalignment?”

Experience and coupling manufacturers maximum misalignment recommendations would suggest otherwise. Anecdotal evidence suggests that as much as 50% of machine breakdowns can be directly attributed to incorrect shaft alignment.



It is true that flexible couplings are designed to take misalignment, typically up to 10mm or more radial offset of the shafts. But the load imposed on shafts, and thus the bearings and seals increase dramatically due to the reaction forces created within the coupling when misaligned. For example a 445 mm vulcan coupling designed for a maximum of 6 mm radial offset at 600 RPM produces a reaction force of 1.2kN per mm of radial offset. (See “laser alignment helps cut shipboard vibration Diesel and Gas Turbine Worldwide Nov 1997)

# Causes of machine breakdown

---

## Anti-friction Bearings

Bearings are precision manufactured components designed to operate with clean lubrication and constant but restricted operating temperatures. Components manufactured within 0.005mm accuracy are:

- Not able to withstand operating for long periods at elevated temperatures caused by misalignment.
- Not able to withstand contamination caused by mechanical seal failure which has allowed ingress of dirt, grit, metallic elements or other objects.
- Not manufactured to operate for long periods with misalignment imposing axial shock loads on the carefully machined and honed components.

In addition to the damage imposed on the bearings through the misalignment itself, when mechanical seals fail, bearings have to be removed from the shaft assembly, sometimes re-fitted or in most cases replaced. Removal and re-fitting in itself can cause bearing damage. Most pump manufacturers and repairers recommend that when repairing damaged pumps, bearings should always be replaced irrespective of apparent condition, since it is easy to miss minor damage to the bearing that will progressively worsen after re-fitting.

## Mechanical Seals

Seal wear increases due to shaft loading when shafts are misaligned. Pump seals are a high cost item often costing up to a third of the total pump cost. Poor installation and excessive shaft misalignment will substantially reduce seal life. Manufacturers have addressed the problem of poor installation practice by the introduction of cartridge type seals which can be installed with little or no site assembly. Seals however have precision ground and honed components with finished accuracy of 2 microns (0.0002 mm) they do not tolerate operation in a poorly aligned condition, face rubbing, elevated temperatures and ingress of contaminants quickly damage expensive components. Seal failure is often catastrophic, giving little or no pre warning, the resultant plant downtime, seal replacement costs, pump repair costs and bearing replacements makes seal failure due to misalignment an expensive and

# **Causes of machine breakdown**

---

unnecessary problem.

## **Machine vibration**

Machine vibration increases with misalignment. High vibration leads to fatigue of machine components and consequently to premature machine failure.

## **The accumulated benefits of precision shaft alignment.**

The benefits that accrue from adopting good shaft alignment practice begin with improved machine operating life thus ensuring plant availability when production requires it. Accurately aligned machinery will achieve the following results.

- Improve plant operating life and reliability
- Reduce costs of consumed spare parts such as seals and bearings
- Reduce maintenance labour costs
- Improve production plant availability
- Reduce production loss caused by plant failure
- Reduce the need for standby plant
- Improve plant operating safety
- Reduce costs of power consumption on the plant
- “Push” plant operation limits in times of production need
- Obtain better plant insurance rates through better operating practice and results

## **Symptoms of misalignment**

It is not always easy to detect misalignment on machinery that is running. The radial forces that are transmitted from shaft to shaft are difficult to measure externally. Using vibration analysis or infrared thermography it is possible to identify primary symptoms of misalignment such as high vibration readings in radial and axial directions or abnormal temperature gradients in machine casings, but without such instrumentation it is also possible to identify secondary machine problems which can indicate inaccurate shaft alignment.

## Causes of machine breakdown

---

- Loose or broken foundation bolts.
- loose shim packs or dowel pins.
- Excessive oil leakage at bearing seals
- Loose or broken coupling bolts.
- Some flexible coupling designs run hot when misaligned. If the coupling has elastomeric elements look for rubber powder inside the coupling shroud.
- Similar pieces of equipment are vibrating less or have longer operating life.
- Unusually high rate of coupling failures or wear.
- Excessive amount of grease or oil inside coupling guards.
- Shafts are breaking or cracking at or close to the inboard bearings or coupling hubs.

Good shaft alignment practice should be a key strategy in the maintenance of rotating machines. A machine properly aligned will be a reliable asset to the plant, it will be there when it is needed and will require less scheduled (and unscheduled) maintenance. In a later section we will review some specific case studies that will show how shaft alignment will deliver substantial cost benefits to operating plants. The next section of this handbook however will review the various methods of shaft alignment that can be used to deliver good installed machinery alignment.

# Alignment methods and practice

---

There are a number of different methods whereby acceptable rotating machine alignment can be achieved. These range from an inexpensive straight edge to the more sophisticated and inevitably more expensive laser systems. We can condense these methods into three basic categories,

- Eyesight – straightedge and feeler gauges
- Dial indicators – mechanical displacement gauges
- Laser optic alignment systems.

Within each category there are a number of variations and options, it is not the intention here to evaluate all of these options, instead we will concentrate on the most widely used methods in each category.

## **Preparation is important.**

The first preparatory step toward successful alignment is to ensure that the machine to be aligned may be moved as required: this includes vertical mobility upwards (using proper lifting equipment, of course) and downwards, should the machine require lowering, as is frequently the case. This can be achieved by inserting 2 to 4 mm (0.08” - 0.16”) of shims beneath the feet of both machines on initial installation (we recommend shimming both machines initially so that changes in the foundation condition may later be compensated, if need be).

Horizontal positioning of machines is best performed using jack bolts or a simple ‘machine puller’ tool or hydraulic equipment, all of which allow fine control of movement in a slow, gentle and continuous manner. Methods such as hammers not only make exact positioning more difficult and can damage machines (by causing chatter marks on bearings), but the vibration could displace the alignment system during the MOVE function and therefore lead to less accurate monitoring of correction positioning.



# Alignment methods and practice

---

## Machine installation guidelines

The installation of machinery such as a pump, gearbox or compressor etc require some general rules to be followed.

- The driven unit is normally installed first, and the prime mover or motor is then aligned to the shaft of the driven unit.
- If the driven unit is driven through a gearbox, then the gearbox should be aligned to the driven unit and the driver aligned to the gear box.
- Basic checks should be carried out to determine the accuracy of the machine couplings, i.e. check for “run-out” (concentricity and squareness to the shaft centrelines) of coupling halves using a dial indicator, if possible (out of “true” coupling halves can cause out of balance problems!).
- Preparation of the machinery baseplate and machine mounting surfaces, feet, pedestals etc. is of paramount importance! Successful alignment cannot be easily achieved otherwise!
- Clean, dress up and file any burrs from mounting faces and securing bolt holes etc.
- Have quality shims available to align precisely and effectively.
- Before assembling the shaft alignment system/ instrumentation to the machines, take a few minutes to look at the coupling/shaft alignment. Remember, your eyes are your first measuring system!
- Check that the pump/motor etc. is sitting square to the base plate. (Soft foot check) and correct as required - see following pages.
- Keep shims to a minimum i.e. no more than 3 shims maximum if possible under machinery feet/mounts.
- Correct alignment as required to ensure that, when the machinery is running, the machinery shafts are centred in their bearings and are aligned to manufacturers tolerances.
- Always check manufacturers alignment figures prior to commencing work! - temperature growth may require specific “cold” alignment offsets.
- Ensure that any pipework attached to machines is correctly supported but free to move with thermal expansion.

# Alignment methods and practice

---

## Measurement and correction of soft foot.

An essential component of any successful alignment procedure is the determination and correction of soft foot. Just as a wobbly chair or table is an annoyance, a wobbly machine mount causes alignment frustration. The machine stands differently each time an alignment is attempted, and each set of checking measurements indicate that the machine is still misaligned. Additionally when the machine is bolted down strain is placed upon the machine casing and bearing housings. Essentially there are two types of soft foot as illustrated in the sketch below.

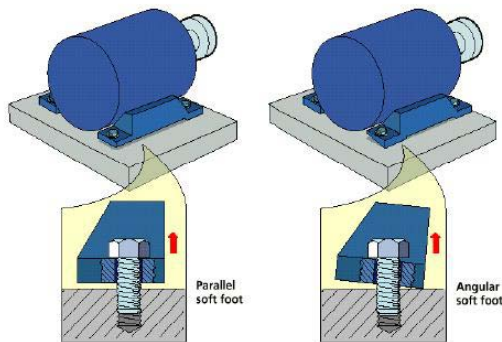

Parallel soft foot indicates that the baseplate and machine foot are parallel to each other allowing correction by simply adding shims of the correct thickness. Angular soft foot is caused by the machine feet forming an angle with one another. This situation is more complex to diagnose and to correct, one solution is to use tapered shims to fill the angular space between the baseplate and the foot, a more drastic but long term solution is to remove the machine and grind the machine feet flat.

## Soft foot measurement

Using a variety of techniques soft foot can be determined prior to

# Alignment methods and practice

---

alignment commencing.

Using a dial indicator mounted on a magnetic foot, position the indicator above one of the machine feet, zero the indicator and then loosen off the machine foot. Record any change in the indicator reading. And retighten the machine foot down. Repeat this for all of the machine feet.

or

Using a set of feeler gauges, loosen one machine foot at a time measure the gap that appears below the loosened machine foot and record this. Retighten the machine foot and move to the next foot.

or

Using a laser alignment system loosen one machine foot at a time the alignment system records the amount of foot lift at each foot. Retighten the machine foot before proceeding to the next foot.

Having determined the amount of soft foot present as indicated below it is possible to make adjustments to the machine according to the soft foot condition diagnosed.

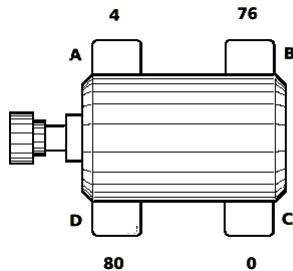

This example shows classic soft foot problems with a rock across feet B and D. It is tempting to shim both feet to eliminate the rock but this would be a mistake. The best solution would be to shim only one foot 80/100 mm and to recheck all four feet.

Many additional soft foot problems may be found including bent feet strain imposed by pipe work or “squishy foot cause by too many shims under the machine feet. Some examples are shown in the following sketches.

# Alignment methods and practice

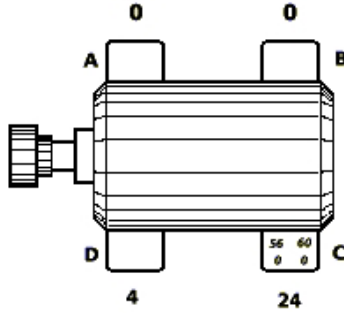

Soft foot example: bent foot - step shim at foot c and recheck all feet

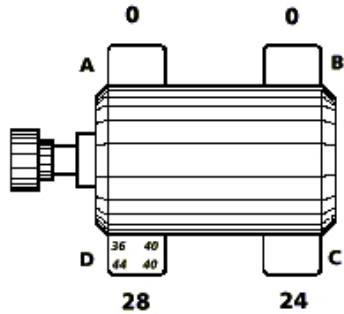

Soft foot example: pipe strain - relieve external forces

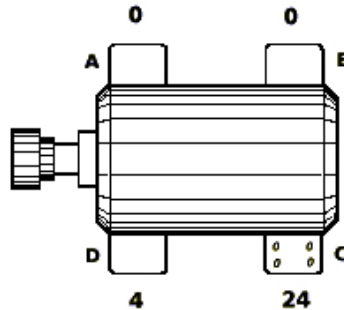

Soft foot example: squishy foot - re shim all feet with max 3 shims and recheck

## **Alignment methods and practice**

---

When eliminating soft foot follow these steps.

1 Check all four machine feet, any foot showing over **0.08 mm** correct as appropriate.

2 Examine the largest (or two largest if the same) soft foot with feeler gauges to determine the type of soft foot. It never hurts to examine the other feet as well, but concentrate on finding and fixing the largest problem first.

3 Correct the condition diagnosed by shimming only one foot if any.

4 If all feet are within tolerance commence the alignment.

# Alignment methods - Eyesight

---

## The straightedge

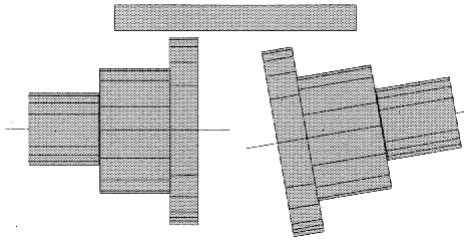

This method of shaft alignment was common practice in many plants, provided a flexible coupling was used, it was considered good enough to eyeball the alignment and bolt the machine down. The system is certainly cheap and equipment is readily available.

The corrective values for the machine feet were usually estimated according to the experience of the engineer carrying out the alignment. Most often corrections at machine feet need to be repeated on a trial and error basis before the “eyeball” alignment condition was completed. Even then there is no certainty that the completed alignment was correct. Since the resolution of the human eye is limited to 0.1mm, alignment accuracy is correspondingly limited. Additionally without having carried out extensive checks on the fitting accuracy of the coupling on the shaft, no direct correlation between the completed alignment and the actual alignment of the machine shafts can be made.

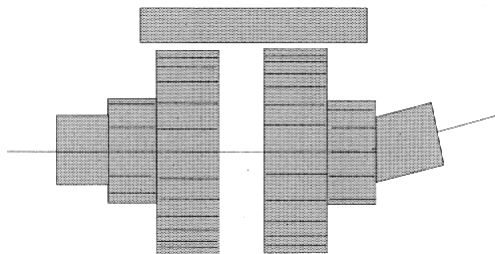

At best this alignment method can be described as coupling alignment not shaft alignment as defined earlier.

# Alignment methods - Eyesight

## The feeler gauge

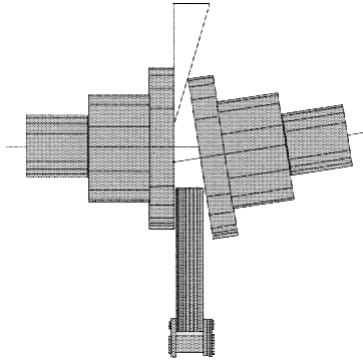

Although classified here as an “eyesight” method of shaft alignment the feeler gauge method under certain circumstances and for some machines can be perfectly acceptable. In the installation and alignment of turbine sets where the coupling half is an integral part of the rotor shaft and has no flexible elements, it is possible for a skilled turbine engineer to align the two coupling halves very accurately. (As noted in the section on alignment tolerances, no allowance for offset or gap is permissible on these “solid” type of couplings)

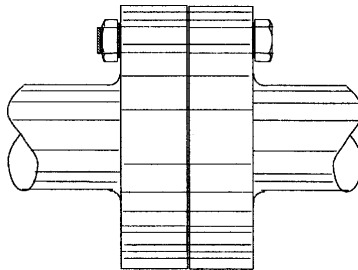

Using the feeler gauge or a vernier caliper the engineer accurately measures any gap between the coupling halves. Jacking oil is then used to rotate the shafts together through 180 degrees and the “gap” is then checked again (with the jacking oil off). This procedure is then carried out for the horizontal alignment measurements.

## **Alignment methods - Eyesight**

---

Readings are usually graphically plotted to establish alignment condition and any necessary corrections that are required. In some cases engineers will rotate one shaft through 180 degrees and take additional readings, these readings are then averaged to eliminate any possible shaft machining errors. The averaged readings form the basis for the alignment graph.

On machines that employ flexible elements in the coupling design, the use of feeler gauges is beset with the same limitations as the straightedge method and can only be described as coupling alignment.



# Alignment methods - Dial indicators

The use of dial indicators for the vast majority of shaft alignment tasks where a flexible coupling element is used represents a substantial step forward in accurate shaft alignment methods. There are a number of dial set ups that can be used to effect the alignment of machines, this section will review some of these, however, there are also a number of factors that the engineer should take into account before embarking on a dial indicator alignment task.



**Indicator bracket sag:** This should always be measured before actual alignment readings are taken - no matter how solid the bracket appears. See section on measuring sag.



**Internal friction / hysteresis:** Sometimes the gauge has to be tapped in order for the indicator needle to settle on its final value.



**1/100 mm resolution:** Up to 0.005 mm rounding error may occur with each reading. This may be compounded several times in a full set of readings.



**Reading errors:** Simple errors occur when dials are read under difficult conditions and severe time constraints.

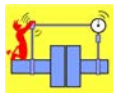

**Play in mechanical linkage:** slight amounts of play may go unnoticed but will produce large reading errors.



**Tilted dial indicators:** The gauge may not be mounted perpendicular to the measurement surface so that part of the displacement reading is lost

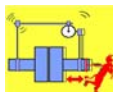

**Axial shaft play:** This will affect face readings taken to measure angularity unless two axial gauges are used.

## Alignment methods - Dial indicators

---

### Rim and Face Method - By trial and error.

The interpretation of shaft alignment readings using dial indicators, taking factors such as bracket sag into consideration requires an elementary understanding of maths and geometry. In some cases these skills are limited and a rough trial and error procedure is used where bracket sag and shaft float are ignored. Additionally only one shaft is rotated during the measurement adding errors to the alignment caused by coupling run-out and shaft bending.

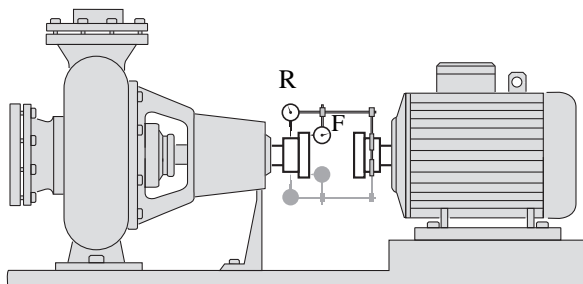

The above sketch illustrates the scenario. Rim and face indicators clock the fixed machine coupling. Indicators are zeroed at 12 o'clock and the machine to be moved shaft is rotated through a half turn to the 6 o'clock position. The foot nearest the coupling is raised (or lowered) by an amount equal to half the rim indicator reading. Shims are repeatedly placed under the foot furthest from the coupling until the face indicator readings do not change as the shaft is rotated.

Similarly the indicators are zeroed at the 3 o'clock position and rotated to the 9 o'clock position for the horizontal correction.

It is usually easy to spot when this procedure is used as there are often a number of thin shims under the rear feet of the machine. Usually this trial and error procedure results in significant misalignment errors at the coupling transmission planes, where possible this method should be discouraged in favor of other dial or laser methods of alignment.

# Alignment methods - Dial indicators

## Rim and Face Method - By calculation

The measuring device for this type of alignment is a dial indicator. The dial hand indicates, or points, to increments marked on the dial face. As the foot is pushed into the body, the dial hand rotates clockwise. The number of indicator marks that the hand moves is equal to the distance that the foot was pushed into the body. When the foot travels out from the body the dial hand similarly indicates the travel distance. The dial count is positive when the foot travels in and negative travelling out.

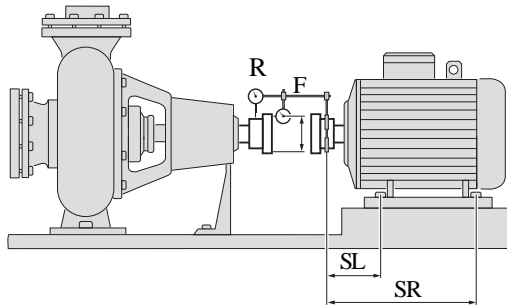

Rim and Face alignment takes its name from the positions of the indicator feet during measurements. A traditional indicator set up is shown above

Once mounted, the two shafts are rotated together and the dials are read at 12:00, 3:00, 6:00 and 9:00.

## Formulas for calculating alignment corrections

For such set ups, the MTBM alignment at the plane of the indicator foot is as follows:

$$VO = (R6 - R0 - RS)/2 \quad VA = (F6 - F0 - FS)/dia$$

$$HO = (R9 - R3)/2 \quad HA = (F9 - F3)/dia$$

## Alignment methods - Dial indicators

---

Where:

R0 = Rim reading at 12:00 o'clock position

R3 = Rim reading at 3:00 o'clock position

R6 = Rim reading at 6:00 o'clock position

R9 = Rim reading at 9:00 o'clock position

F0 = Face reading at 12:00 o'clock position

F3 = Face reading at 3:00 o'clock position

F6 = Face reading at 6:00 o'clock position

F9 = Face reading at 9:00 o'clock position

dia = Diameter of the circle travelled by face indicator foot

RS = Sag of Rim indicator \*

FS = Sag of Face indicator

s = Span from measurement plane (rim indicator foot) to machine foot (front or back) This value can be positive or negative

Clockwise is determined looking along shaft from MTBM towards STAT.

$$\text{Shim} = (VA)(s) - VO$$

$$\text{Shim} = (F6 - F0 + FS)(s) / \text{dia} - (R0 - R6 + RS) / 2$$

$$\text{Move} = (HA)(s) - HO$$

$$\text{Move} = (F9 - F3)(s) / \text{dia} - (R3 - R9) / 2$$

If the dial indicators are set to zero at 12:00 and then read at 6:00, the shim calculation becomes:

$$\text{Shim} = (F6 + FS)(s) / \text{dia} + R6 - RS / 2$$

## **Alignment methods - Dial indicators**

---

Positive result means add shims Negative result means remove shims

If the dial indicators are set to zero at 3:00 and then read at 9:00 the MOVE calculation becomes:

$$\text{Move} = (F9)(s)/\text{dia} + R9/2$$

Positive means move toward 3:00

Negative means move toward 9:00

The Shim and Move calculations must each be done twice, once for the front feet, and once for the back feet.

### **Indicator reading validity rule.**

The sum of the 3 and 9 o'clock readings should equal the sum of the 12 and 6 o'clock readings. This applies to both radial and face readings.

### **Sag**

A major source of error in the above procedure is the sag of the spanner bar. This error can affect the shim amounts to such an extent that the machine will be grossly misaligned. To compensate for this sag, measure it and then add the sag reading (it can be positive or negative) to the 6:00 readings. See the above formulas.

# Alignment methods - Dial indicators

## Reverse indicator method - By calculation

The reverse indicator method of alignment is the most advanced dial indicator alignment method, as such it is recommended by the American Petroleum Institute (API 686) as the preferred dial indicator alignment method

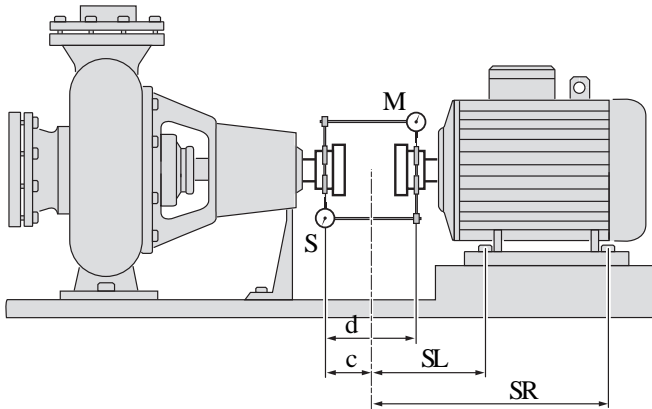

Reverse indicator alignment takes its name from the positions of the indicators opposing one another on the opposite coupling halves. A traditional indicator set up is shown above.

Once mounted, the two shafts are rotated together and the dials are read at 12:00, 3:00, 6:00 and 9:00.

## Formulas for calculating Reverse indicator alignment

For such set ups the misalignment at the coupling centre is as follows

$$VO = (S6-S0+SS)/2 - (S6-S0+SS +M6-M0-MS)C/2D$$

$$VA = (S6-S0+SS +M6-M0-MS)/2D$$

$$HO = (S9-S3)/2 - (S9-S3+M9-M3)C/2D$$

$$HA = (S9-S3+M9-M3)/2D$$

## Alignment methods - Dial indicators

---

Where:

S0 = Left rim reading at 12 o'clock

S3 = Left rim reading at 3 o'clock

S6 = Left rim reading at 6 o'clock

S9 = Left rim reading at 9 o'clock

M0 = Right rim reading at 12 o'clock

M3 = Right rim reading at 3 o'clock

M6 = Right rim reading at 6 o'clock

M9 = Right rim reading at 9 o'clock

D = Distance between left and right indicators

C = Distance between left indicator and coupling centre

SS = sag of left rim indicator (1)

MS = sag of right rim indicator (1)

(1) these values can be positive or negative

The corrections at the right machine feet can be calculated as follows

Shim left feet =  $(VA - sL) - VO$

Shim right feet =  $(VA - sR) - VO$

Positive result means add shim, negative result means remove shim.

Shim left feet =  $(VA - sL) - VO$

Shim right feet =  $(VA - sR) - VO$

Positive result means move towards 3 o'clock, negative means move toward 9 o'clock.

sL = Distance from the coupling centre to left feet of right m'ce

sR = Distance from the coupling centre to right feet of right m'ce.

If the dial indicators are set to zero at 12 o'clock and then read at 6 o'clock the shim calculation are as follows:

$$HO = (S9 - S3) / 2 - (S9 - S3 + M9 - M3) C / 2D$$

$$HA = (S9 - S3 + M9 - M3) / 2D$$

## **Alignment methods - Dial indicators**

---

$$\text{shim left feet} = (S6-S3+M6-M3)(c+sL)/2D - (S6-SS)/2$$

$$\text{shim right feet} = (S6-S3+M6-M3)(c+sR)/2D - (S6-SS)/2$$

Positive result means add shim, negative result means remove shim.

If the dial indicators are set to zero at 3 o'clock and then read at 9 o'clock the move calculations are as follows:

$$\text{move left feet} = (S9+M9)(c+sL)/2D - S9/2$$

$$\text{move right feet} = (S9+M9)(c+sR)/2D - S9/2$$

Positive result means move towards 3 o'clock, negative means move toward 9 o'clock.

Sag calculations see following section.



# Alignment methods - Dial indicators

## Reverse indicator method - By Graph

The calculations shown in the previous section can be daunting for many engineers and unlike with rim and face measurement trial and error corrections are not possible, but to avoid mathematical computation a graphical solution can be used to resolve the alignment condition and the necessary shim and move corrections.

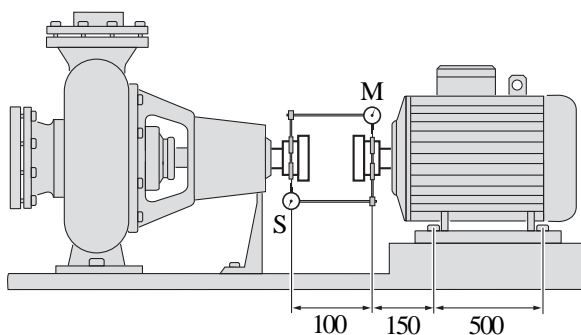

The sketch above shows a typical reverse indicator configuration with the right machine as the machine to be moved (MTBM). Both indicators are zeroed when the indicators are in the 12 o'clock position. The direction of view is from the MTBM to the stationary machine. The shaft is rotated through 180 degrees in the direction of normal shaft rotation. Dial values are read and noted, as an example assume the following readings were taken

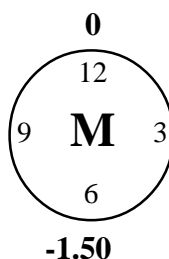
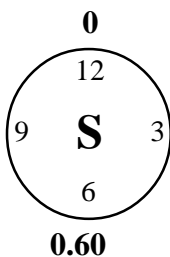

*All values shown in mm*

# Alignment methods - Dial indicators

The indicator bracket sag was - 0.10 mm. The total indicator readings (TIR) after correction for bracket sag are thus:

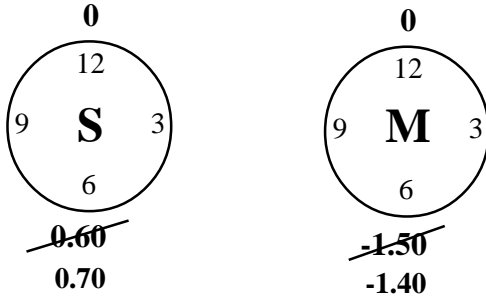

TIR values must be divided by 2 to determine the true shaft offset values in the planes of the dial indicators.

$$\text{offset } S = +0.70 / 2 = +0.35 \text{ mm}$$

$$\text{- offset } M = -1.40 / 2 = -0.70 \text{ mm.}$$

These offsets are then plotted on the graph as follows

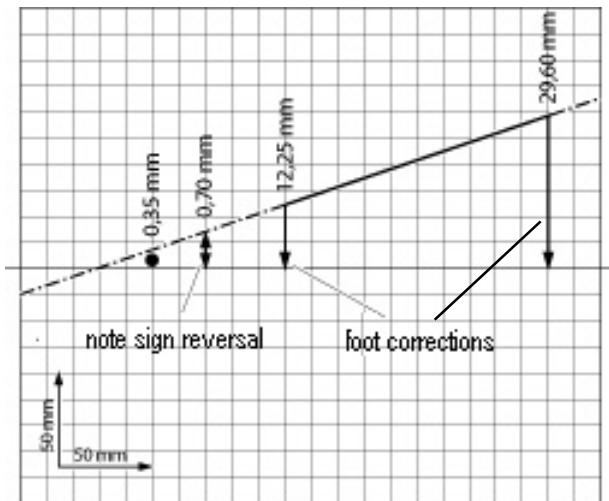

# Alignment methods - Dial indicators

Both indicators are then zeroed with the indicators at the 3 o'clock position. The shaft is rotated through 180 degrees in the direction of normal rotation. The readings are noted. On returning the shafts to the 3 o'clock position the indicator readings should return to zero.

Assume the following readings were taken:

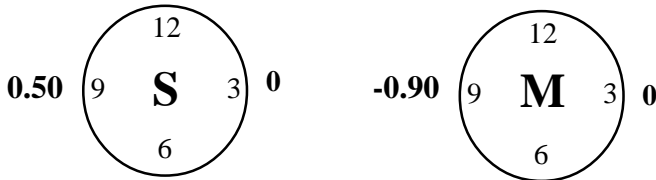

Sag correction values are not applicable to horizontal readings.

TIR values must be divided by 2 to determine the true shaft offset values in the planes of the dial indicators.

offset S =  $+0.50 / 2 = +0.25$  mm

- offset M =  $-0.90 / 2 = -0.45$  mm

These offsets are then plotted on the graph as follows

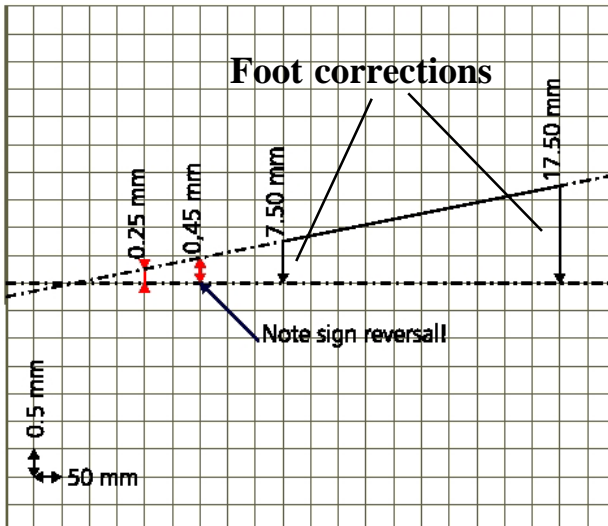

## **Alignment methods - Dial indicators**

---

Vertical and horizontal shim corrections are shown on each graph the corrections assume that the alignment should be 0.0/0.0 in vertical and horizontal planes. Any manufacturers figures or computed figures for thermal expansion should be accommodated in these shimming corrections or in the original dial indicator readings.

### **Indicator Bracket Sag Measurement**

To measure sag mount the entire measurement fixture (brackets, bars and indicators) onto a piece of straight pipe. Adjust the fixture until the brackets are the same distance apart as they will be when they are mounted on the actual machinery. Likewise position the indicators as near possible to the way they will be set on the machinery. With the indicators held at the 12 o'clock position zero the dials. Rotate the pipe until the indicators are at 6:00 o'clock. Read and record the dial indicators (the rim indicator will be a negative value, the face indicator may be positive or negative but should be close to zero)

# Laser shaft alignment

---

Shaft alignment by laser became popular in the mid 1980's when Pruftechnik introduced OPTALIGN the worlds first commercially available computer aided laser shaft alignment system. Despite its then relatively high price, the system quickly gained a market popularity with engineers and companies across a wide spectrum of process industries world wide.

OPTALIGN offered many significant advantages in effecting quick and accurate alignment of coupled rotating machines. Since the introduction of the first system developments in laser and microprocessor technology has allowed a new generation of laser systems to be developed which offer the user simple to understand, menu led, systems that can be used for virtually any shaft alignment task irrespective of complexity or size.

As we have seen in the previous sections there are a number of important considerations that should be taken into account when using mechanical methods of shaft alignment, additionally calculations of alignment corrections can be complicated and error prone. None of the considerations apply to the laser method of shaft alignment. Access to precision shaft alignment and the benefits that this brings (see following section) is readily available when laser shaft alignment is used on plant.

A summary of some of the advantages offered by laser systems are shown here:

- Precision alignment with no manual input of data and no graphical or numeric calculations to perform.
- Graphic display of alignment results at the power transmission planes of the coupling and shim and adjustment corrections at the machine feet.
- No mechanical fixtures - no bracket sag.
- No need to disassemble the coupling to effect an alignment.
- No need to take readings at predetermined locations such as 12;00, 3;00, 6;00 and 9;00 o'clock. Results can be obtained with less than 90 degrees of shaft rotation.

# Laser shaft alignment

---

- Data storage and print out of results for report generation of alignment condition
- Certified calibrated accuracy of the laser system to comply with ISO900 requirements.
- Universal bracket systems which cover all types of alignment application. No need for special “Christmas tree” brackets for long spacer shaft measurement.
- Menu driven operator system allows use by a wide range of engineering skills and disciplines.
- Live dynamic display of vertical and horizontal corrections during alignment corrections.
- Inbuilt go - no go alignment standards for analysis of alignment accuracy.

Having identified some of the benefits and advantages that can be obtained by using a laser alignment system to carry out shaft alignment, it is important to establish the functionality of the alignment system that will suit the users requirements. There are a number of systems available and a number of manufacturers who offer laser alignment systems.

As a minimum the system you choose should have the following capabilities:

- **Certified calibration to a traceable standard.** There is no point purchasing a system for accurate shaft alignment that cannot have its measurement accuracy certified.
- **High accuracy and repeatability.** Poor accuracy simply results in wrong correction values. High repeatability means that fewer measurements are required to acquire sufficient data to calculate accurate results.
- **Rugged, water, shock and dust proof** A rugged enclosure means outdoor use in wet conditions is not a problem. Rugged instruments with a guaranteed seal of approval like the IP standards(65 and 67) let you continue working even in adverse conditions.

## Laser shaft alignment

---

- **Measurement resume capability** Resume allows you to easily re-start an alignment in progress after an interruption or at the start of a new day the user won't have to input dimensions or targets again, even measurement results will be saved. Data will never be lost.
- **Measurement extend capability** The ability to extend the dynamic range of the laser detector system will ensure that no matter what the misalignment being measured the laser system will cope with the alignment task. Static detector systems will not allow measurement of gross misalignment on long or intermediate spacer shafts what ever the stated size of the detector plane. (See later notes).
- **Interchangeable static feet** The ability to vary static feet allows the engineer maximum flexibility and the ability to deal with bolt bound feet on the MTBM without the need for re-measuring or complex calculations; all possible alternatives of machine move can be shown.
- **Assortment of brackets** A wide range of brackets means that measuring equipment can be fitted even to the most awkward of machines with speed and ease.
- **Tolerances (TolCheck)** Built in verification of alignment tolerances save time and effort. No time is wasted on unnecessary machine moves. Automatic tolerance check shows when excellent or acceptable alignment has been reached.
- **Report generation directly from the box** Direct reporting means faster reporting **to any printer** with the serial number, date and time, and operator name printed on the report, allowing full compliance with ISO 9000 traceability requirements for example.

# Laser shaft alignment

---

## Laser systems basic operating principles.

Essentially there are two types of laser system one that uses a single beam projected onto either a detector or on to a reflector that returns the beam to the laser detector, the other type of system uses two lasers each with inbuilt detectors. The former single laser system is a patented system used exclusively by Pruftechnik, the two laser systems are employed by all other system suppliers.

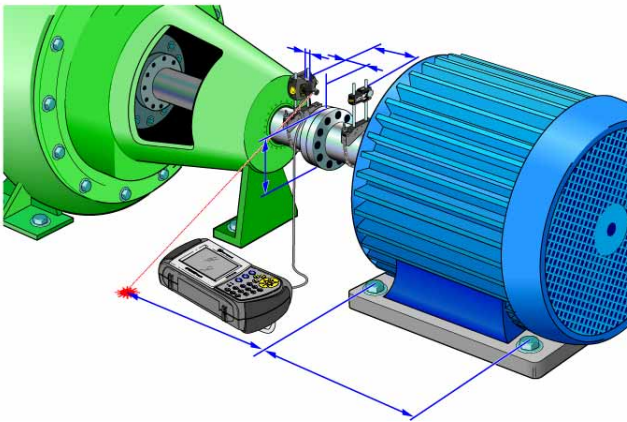

The single laser system as shown above has a number of advantages that have been incorporated to improve system versatility and useability.

**Measurement extend capability** - only one laser datum means that it is possible to dynamically extend the detector range of the system to incorporate gross misalignment - see later explanation.

**Split alignment capability** - one laser allows alignment of machines that have no spacer or coupling in place, each machine can be rotated independently. This is particularly useful when large spacer couplings or fluid couplings are used, when aligning large machines such as turbines or when one or both machines cannot easily be rotated.



# Laser shaft alignment

**Single cable technology** - Only one (or no) cable is required. This is particularly useful on long spacer shafts such as cooling tower drives where long cables can influence alignment measurements by becoming entangled during measurement.

**Only one laser to adjust** - On long spacer shafts or large machines set up is much easier with only one fixed datum position to adjust.

## Measurement extend capability explained.

Why would it be useful to be able to extend the range of the detector plane on a shaft alignment system, surely it would be better to have a larger detector area? Well, yes, theoretically it would be useful to have a static detector plane of 500 mm. But the system would be unuseable simply because of size and weight. An ideal compromise is to dynamically extend the detector plane if it is required. This keeps the system to a minimum size and weight and therefore maximises the systems use in difficult to access areas.

Taking as an example a cooling tower drive with a spacer shaft coupling of 3000 mm. The offset between the driver and driven shafts can be substantial even with only a small angular offset between the shafts.

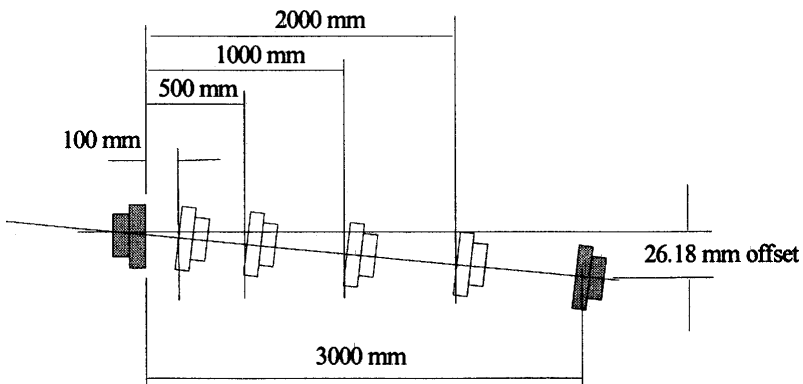

# Laser shaft alignment

This previous sketch illustrates the limitations imposed by long spacer coupling lengths.

Taking as a simple example a coupling set up with an angular misalignment between the couplings of **0.5 degrees**, this means over a simple short coupling length of 100 mm an offset of 0.87 mm between coupling centerlines would occur. An offset that could be comfortably measured by any laser system.

If the distance between coupling faces increases to 500 mm the centerline offset becomes 4.36 mm, out side the range of most static laser detector systems.

Now increase the distance to 1000 mm offset = 8.72 mm,

As the coupling spacer gets longer so does the offset until at 3000 mm a massive 26.18 mm offset occurs. This with only a 0.5 degree angle between the shaft centerlines!

This large offset can only be measured by an extendable detector range since it would require a static detector area of approximately 60 mm to accomodate this offset.

The reason for such a large detector can be explained as follows:

The working area of the detector is less than the physical detector surface. For example, if the detector area is 20 x 20 mm, and the laser beam is 4.0 mm dia then the maximum useful measurement range is 16 mm as shown below.

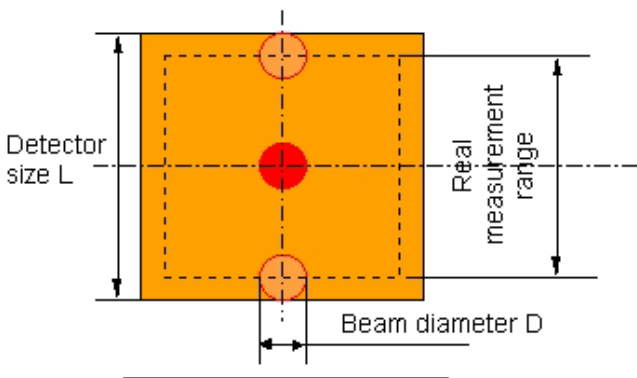

# Laser shaft alignment

To be able to measure an offset a system detector range has to be twice the offset. As with a dial gauge, the laser receiver measures twice the physical offset of the two shafts as shown below.

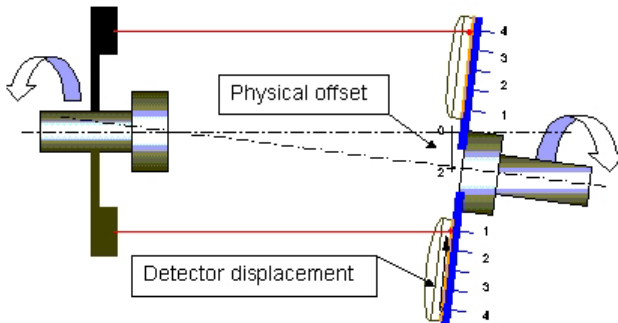

To measure a physical offset of 2.0 mm we need a detector measurement range of 4.0 mm.

A measurement extend capability you may say is all very well if you measure cooling tower drives or other long spacers but when the maximum spacer measurement is less than 1 meter, why is this ability to extend the detector range important?

An example of the benefit of this ability to extend the detector range is illustrated here with a real application.

A motor / fan drive was measured, as shown below

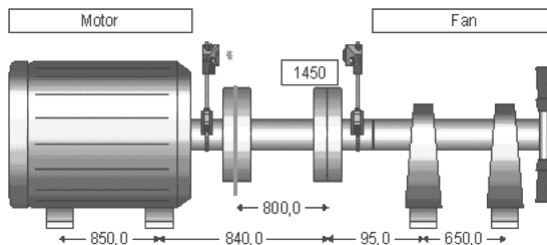

# Laser shaft alignment

The coupling spacer length was 800 mm. Measured offset and gap was:

Vertical = 0.00 offset 0.72 mm gap  
 Horizontal = 0.00 offset 1.05 mm gap

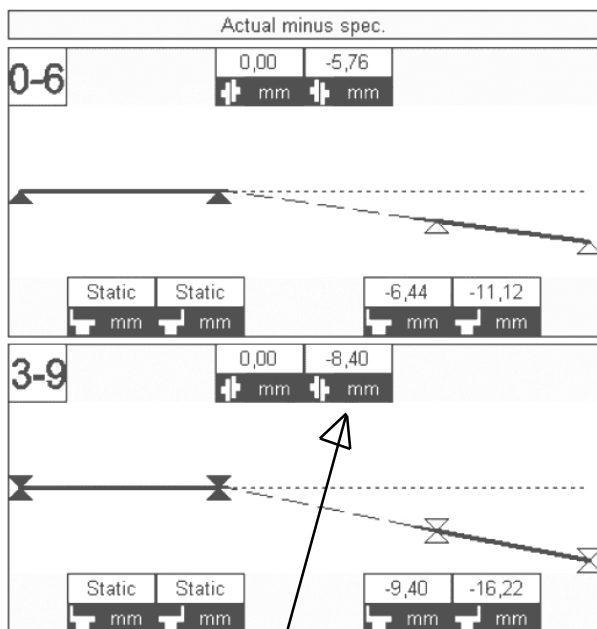

To facilitate this measurement it is necessary that the detectors are able to measure an offset of 8.40 mm, for this the detector range has to be 20.8 mm. This is derived from the following formula:

Measured offset x 2 + beam diameter,  
 $(8.4 \text{ mm} \times 2) + 4 \text{ mm} = 20.8 \text{ mm}$ .

Depending on the specific requirements encountered in day to day alignment tasks the ability to extend the system detector range could be the single most influencing factor in choosing a measurement system. Which ever laser alignment system is chosen however the operating plant will gain substantial benefits as illustrated in the following case studies.

# **Laser shaft alignment - Case study**

---

## **Laser Shaft Alignment Cuts Energy Costs.**

A project to determine the extent to which shaft misalignment influenced the power consumption of the plant was set up as a graduate student project at a major UK chemical processing plant. The study was conducted over a six week period in a controlled environment that accurately reflected the normal operating conditions across the plant.

A 7.5 kW pump rig on a redundant plant was used for the investigation. Before the project commenced the pump and motor were removed to the workshop where new bearings were fitted, and both units were rebalanced to eliminate any external factor that could distort the project results. Plates and jacking bolts were attached to the motor base plate to allow fine adjustments in alignment condition. The pump set was installed to circulate water through a closed loop of piping with the motor running at 3000 rpm (+/- 1% due to variations in load condition). The pump and motor were initially installed with the alignment recorded as 0.00 gap and offset in the vertical and horizontal directions. The system was run in this condition for a number of days with current drawn being measured at the distribution board every few hours. During the course of the trial period the alignment of the machines was adjusted and at each misalignment interval run for a set period with current drawn measured at regular intervals.

Across the site the two principle types of coupling installed were “pin” and “tyre” couplings. In order to obtain a reasonable picture of potential savings that could be made on the plant both types of coupling were installed with the same amount of misalignment/current measured on each coupling type.

The results of the study are shown in the following graphs. Offset misalignment affected power consumption more than angularity; angular misalignment affected power drawn by “pin” type couplings more than “tyre” couplings. The components of misalignment are additive irrespective of whether the misalignment was vertical or horizontal.

# Laser shaft alignment - Case study

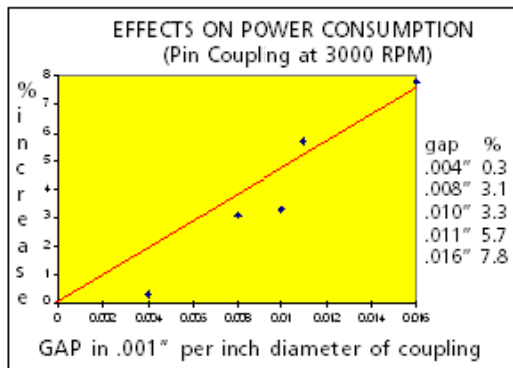
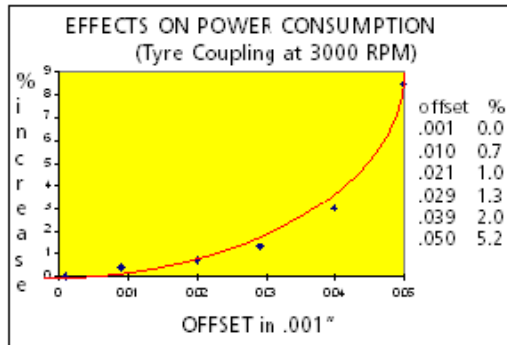
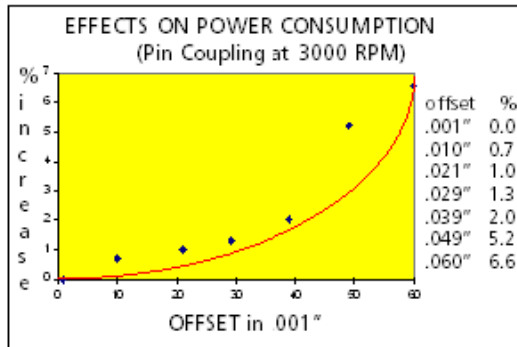

## Laser shaft alignment - Case study

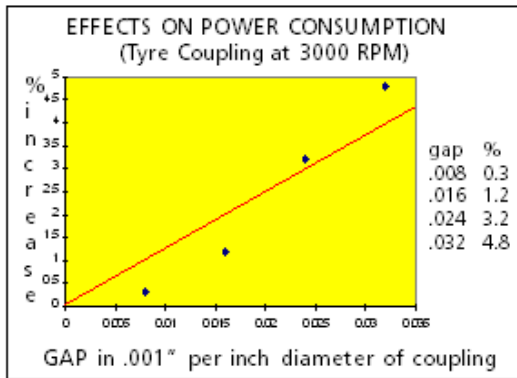

It was concluded from the project that a site wide recommendation to align machines to within an offset tolerance of 0.005 inches and an angularity tolerance of 0.0005 inches per inch of coupling diameter.

To estimate the potential cost savings that could accrue from this new site standard a random sample of machines were measured to estimate the extent of misalignment that existed on the plant. The pie chart below illustrates the findings of this survey.

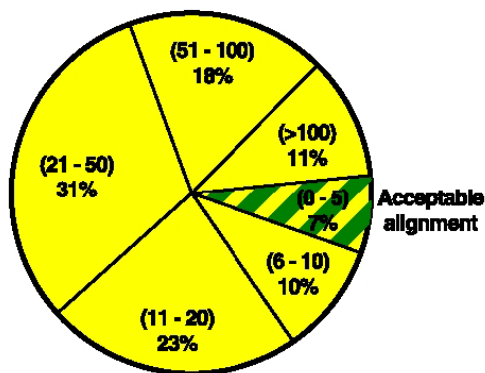

*Shaft offsets in 1/100 mm at the coupling centre for a sample of 100 machines operating at 3000 rpm.*

## **Laser shaft alignment - Case study**

---

Less than 10% of machines measured were within the recommended site alignment standard.

Using the pie chart a representative median offset of 0.35 mm was estimated as a reasonable figure for calculating the potential power saving on the plant. Given that the power consumption for the rotating equipment on the plant was in the range of 30 Megawatts, the following estimate of power saving that could be achieved was:

Assuming electricity rates of £0.03 per kWh and a conservative % power reduction of 0.75%.

$30,000 \text{ kW} \times 0.75\% \times £0.03 / \text{kWh} = £6.75 \text{ per hour}$

or £50,680 per year!



# **Laser shaft alignment - Case study**

---

## **Laser shaft alignment improves pump reliability.**

Substantial plant operating improvements were achieved following the introduction of a comprehensive pump alignment and monitoring program at a major Acetate Chemical plant in Derbyshire.

The production process requires materials to be mechanically moved around the plant from process stage to process stage. Some 260 pumps are used on this plant, it is therefore vital that both duty and stand-by plant is reliable and available. Maintenance was very much a firefighting exercise until 1996. The plant engineer at that time persuaded management of the need to take a more pro-active view of pump performance maintenance and monitoring. Using PRUFTECHNIK laser alignment systems and condition monitoring equipment a coordinated plan to improve plant performance was introduced.

In the preceding years there had been an estimated 120 pumps repaired per year at an annual cost of some £98,000, the calculated mean time between failure (MTBF) of these pumps was 10 months.

By applying a combination of laser alignment of newly refurbished machines and alignment of installed machines when time permitted plus routine plant condition monitoring together with a comprehensive review of installed components such as seals, bearings and gaskets the plant began to see significant savings on maintenance of the all important pump systems.

The program, now well established, has returned substantial dividends. Plant reliability has improved to more than 46 months MTBF and routine pump repairs have been drastically reduced.

Calculated savings are now in excess of £80,000 per annum, and since the beginning of the programme in 1996 is in the order of £450,000!

A comprehensive plan of action was used by engineers to achieve these extraordinary savings on the plant, the key factors include:

## **Laser shaft alignment - Case study**

- Engineers and managers commitment to the programme.
- Patience!
- Laser Alignment.
- Condition monitoring.
- Training.
- Root cause analysis.
- Careful mechanical seal selection.
- Careful bearing selection.
- Partnerships with suppliers.
- Improved piping design and installation.
- Considered pump selection.
- Advanced lubrication systems selection.

## Laser shaft alignment - Case study

### Laser shaft alignment improves bearing and seal life.

A study was conducted by the Infrasppection Institute in the USA to evaluate the affect of misalignment on key machine elements such as bearings, seals and couplings.

In a series of tests, misalignment was introduced into a pump motor set. At each new misalignment interval thermographic pictures were taken to identify the degree of temperature rise on key components.

The tests were conducted across a wide variety of flexible coupling types. Without exception all couplings, bearings and machine housings (and therefore seals) showed significant temperature rise. The graphic below shows the affect of misalignment on components when the machine set was aligned to  $\pm 0.05$  mm and when the misalignment was increased to  $+ 0.5$  mm.

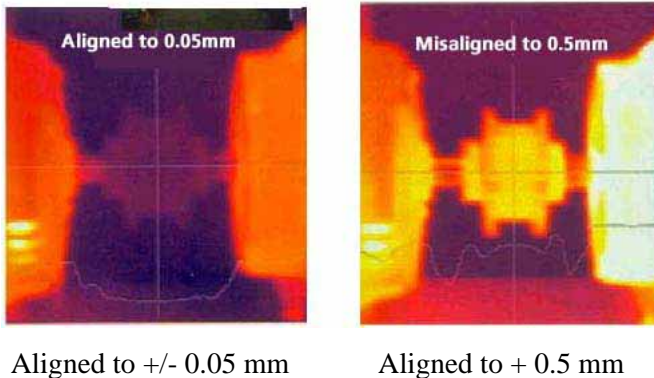

Not only was the flexible element of the coupling shown to heat up, but the machines themselves also develop elevated temperatures particularly around the bearing housings. Neither bearings nor seals are designed to operate at the elevated temperatures caused by misalignment for prolonged periods of time. An inevitable result of their operating in these conditions is premature failure and reduction in machine operating life.

# Laser shaft alignment - Case study

## Laser shaft alignment reduces vibration alarms.

During the period from 1987 to 2000 a major UK petroleum refinery adopted laser shaft alignment as a standard policy for all coupled rotating machinery. Using the Pruftechnik OPTALIGN system and later the ROTALIGN system. Over the period they also monitored the incidents of vibration alarms and how, if at all, the use of laser shaft alignment would help reduce this. Alarms were broken down into problems caused by “misalignment” and “other” problems such as bearing damage, unbalance and mechanical looseness.

The graph provided by the company shows clearly that a substantial reduction in alarm violations was achieved, with those of alignment related problems all but eliminated altogether.

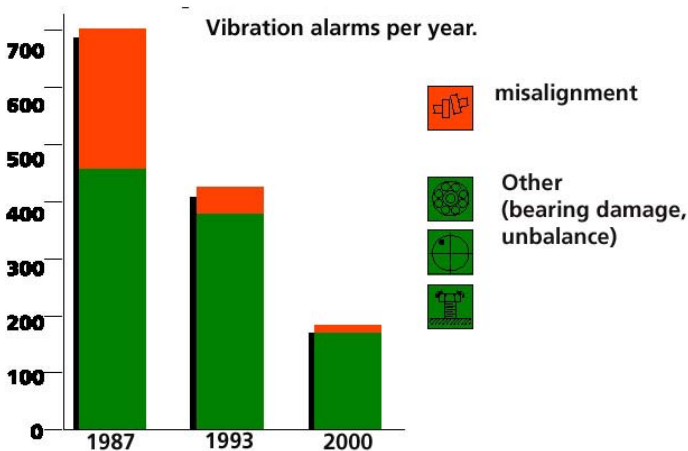

# Thermal expansion of machines

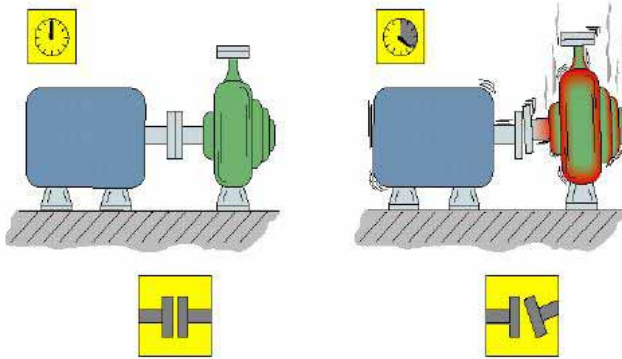

In most cases in this handbook, we have considered only the cold alignment conditions of rotating machines. However, for larger machine sets and for equipment that operates at elevated temperatures on one component of the machines set it is necessary to consider the effects of expansion (or contraction) on the alignment condition of the machine. There is little point in accurately aligning a machine set at cold if this alignment condition will change at the normal operating condition of the machine set. There are a number of ways of establishing the final alignment or operating alignment condition.

- Manufacturers of machines should be able to provide thermal offset information
- Imperial calculation based on coefficient of Thermal Expansion for specific materials per unit length of centre line height per degree of thermal change (see following page).
- On line measurement of cold to hot alignment condition using contact or non contact alignment measurement instruments.

Estimating or calculating the effective alignment position change is by no means a simple operation. On complex machine systems such as compressors where there are a number of machine elements each with varying temperature gradients simple thermal growth calculations become very complex. In these cases on-line measurement of the machine components is usually necessary.

## Thermal expansion of machines

---

In these cases laser systems such as the Pruftechnik PERMALIGN system is an ideal tool. Systems such as PERMALIGN must be designed for long term operation in difficult conditions, often the very act of mounting the equipment onto a turbine or compressor operating in excess of 300 degrees C will mean that the measurement system needs to be cooled to avoid damage or inaccurate thermal growth readings.

Thermal expansion is not however the only cause of machine position change. Many elements can impinge on the accuracy of the final result such as:

- Thermal Expansion of bearing supports
- Changes in radial or axial forces
- Changes in oil film thickness on bearings
- Changes in foundation or base plate supports
- Changes in piping forces.

### Thermal growth calculations

If the direction and extent of growth are known, the machines may be purposely misaligned such that they grow into place, resulting in good alignment condition during normal operation. Optalign Smart<sup>®</sup> OPTALIGN<sup>®</sup> PLUS and ROTALIGN Ultra<sup>®</sup> contains a special function designed especially to incorporate such alignment target values. The most readily available target specifications for cold alignment are generally obtainable from machine manufacturers where this information is not available the following calculations will assist in establishing thermal growth.

$$DL = L (a) (DT)$$

Where

DL	= thermal expansion
L	= height centreline to base of machine
a	= coefficient of thermal expansion of material (.0000059 for cast iron)
DT	= change in temp from ambient.

## Thermal expansion of machines

---

For example:

A pump with liquid at 300°F.  
Base to centre height 26 inches.  
Ambient temp 50°F.

$$DL = L (\alpha) (DT)$$

$$DL = 26 \text{ inches } (.0000059) \times (300-50)$$

$$= 26 \text{ inches } (.0000059) \times 250 = .038 \text{ inches}$$

*(Some advanced laser alignment systems such as Rotalign Pro perform these calculations for you)*

# **OPTALIGN Smart<sup>®</sup> laser alignment system**

---

Optalign Smart<sup>®</sup> is a truly versatile laser shaft alignment system, designed with simplicity of operation as is first principle, the system has many innovative features including;

- Bluetooth<sup>®</sup> communication to sensors and printers
- Simple menu led operation with live on screen help text,
- Multi-function alignment capabilities including bore concentricity and flatness
- Real machine graphics.
- Machine trains
- Obsolescence protection via web upgrades,
- High resolution back lit colour screen
- On board memory capacity for 500+ individual alignment measurements.

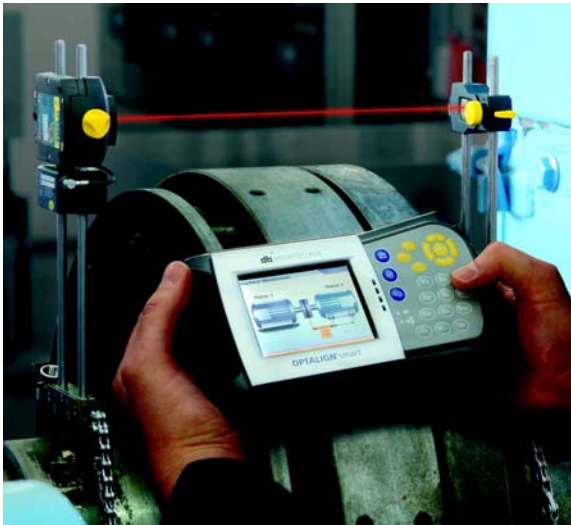

Building on 25 years of shaft alignment experience Optalign Smart<sup>®</sup> uses Pruftechnik's patented single laser technology to deliver accurate alignment results every time whatever the difficulty or restrictions imposed on the measurement task.



# OPTALIGN Smart<sup>®</sup> laser alignment system

Step by step the user is led through the measurement procedure, on screen prompts and live help menus ensures that anyone can perform an accurate shaft alignment in minutes.

*clear graphics and on screen prompts leave no room for doubt*

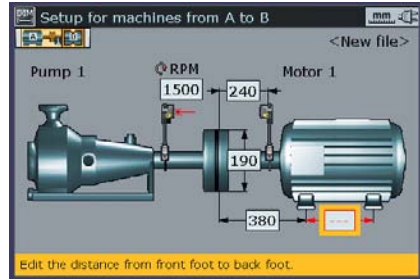

In just 60 degrees of rotation from any start position Optalign Smart<sup>®</sup> provides alignment information at the coupling plus shimming corrections at the machine feet.

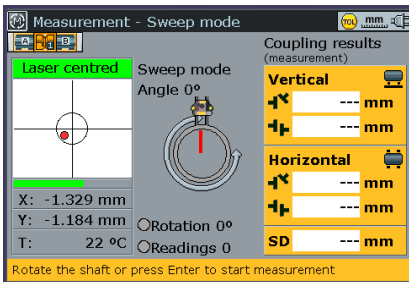

*Simple laser set up, guided throughout by the on screen help and information bar makes measurement a simple process*

*The unique colour graphics screen shows clearly the angle of rotation during measurement.*

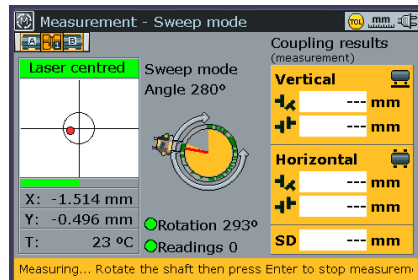

# OPTALIGN Smart<sup>®</sup> laser alignment system

Built in alignment tolerances allow operators to make on the spot decisions on measured alignment accuracy, and comprehensive report generation to any commercially available printer direct from the Optalign Smart<sup>®</sup> computer provides instant documentation of final alignment condition.

With the ability to select a number of alignment measurement options, the ability to fix any feet combinations, to define coupling types, and to input thermal growth information at couplings or feet, Optalign Smart<sup>®</sup> delivers all the functionality identified as necessary for a laser shaft alignment system and more.

*the result screen shows clearly the vertical and horizontal coupling and foot corrections*

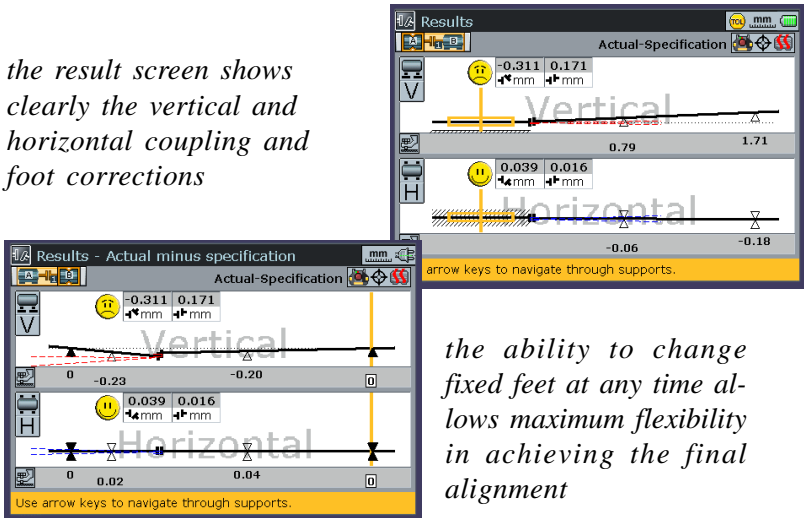

*the ability to change fixed feet at any time allows maximum flexibility in achieving the final alignment*

*windows style drop down menu options makes selection of coupling type and other functions simple*

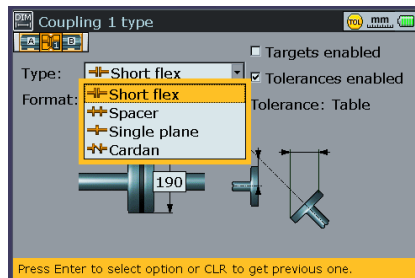

# OPTALIGN Smart<sup>®</sup> laser alignment system

To further aid accurate ‘one stop’ shaft alignment Optalign Smart<sup>®</sup> has live horizontal and vertical position monitoring which enables the operator to view on screen the alignment correction as it happens.

This is particularly useful when horizontally moving the machine and when bolting down machines onto suspected uneven foundation or problem base plates.

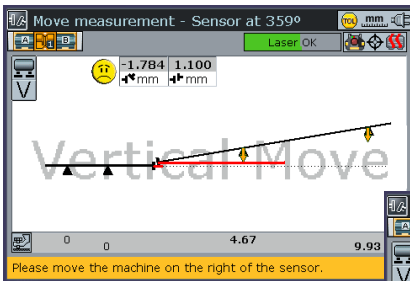

*vertical and horizontal move facilities makes for simple alignment correction*

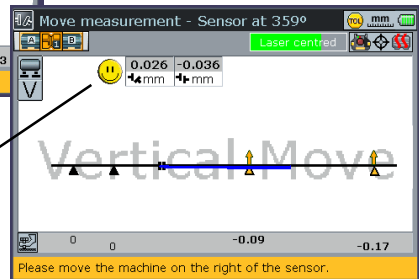

When the ‘smiley’ face appears in the move screen the operator knows that the alignment is within the desired specification for the machine speed and type.

# PULLALIGN<sup>®</sup>

*Pulley alignment is just 3 easy steps away....*

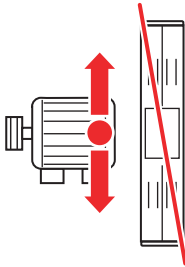

**Vertical angularity**

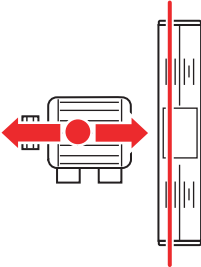

**Axial Offset**

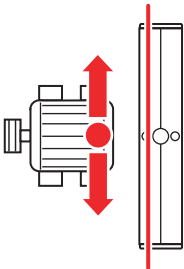

**Horizontal angularity**

- Displays offset and angular misalignment
- More accurate and efficient than wires and straightedge
- Set up is quick and requires no training
- Prolongs belt and pulley life
- Reduced vibration and belt noise
- Reduces downtime, man-power needed and energy costs

## **Alignment of Pulleys and Sheaves**

---

The use of flexible belt drives represents a significant percentage of all industrial power transmission applications, particularly when the speed of the driver and driven shafts are different or where shafts have to be widely separated. There are obviously a number of design factors that preclude the use of flexible belts but where appropriate such drives offer an efficient and economic design solution with some useful advantages over other means of power transmission including :-

- Overall economy
- Cleanliness
- No need for lubrication
- Low maintenance costs
- Easy installation
- Damping of shock loads
- The ability to be used for variable speed power transmission between widely spaced shafts

The power that is transmitted by a belt during operation works on the rim of a pulley therefore the belt on a pulley drive system must be tight enough to prevent 'slip' during operation. The forces that work during operation are not uniform around the entire belt length, there is always a tight side tension and a slack side tension, the difference between these pulls is often called by manufacturers of belts systems the effective or net pull. This effective pull is applied at the rim of the pulley and is the force that produces work.

The design of pulley systems and the selection of correct belt design and application is by no means simple. The number and variety of belt types is a testament to this. Manufacturers of belts and pulleys do not produce a wide range of different types and styles just to be different from their competitors. Vee belts, Flat belts, Wedge belts, synchronous belts etc. all have their specific design applications and application criteria, and within each design section there are numerous different configurations, cross sections and operating criteria.

It is not the brief of this section to consider either belt design or selection.

## **Alignment of Pulleys and Sheaves**

---

There is listed in the bibliography at the end of this book a number of useful guides to belt selection and design.

It is however useful to note the following basic design criteria

- The maximum centre distance of pulleys should be around 15 times that of the pitch of the smallest pulley, and should not exceed 20 times the pitch of this pulley. Greater distances than this require tight control of belt tension because a small amount of stretch will cause a large drop in belt tension, creating slip and power transmission inefficiency.

During operation a flexible belt experiences three types of tension as it rotates around a pulley.

- Working tension (tight side - slack side)
- Bending tension
- Centrifugal tension

Belts are designed to withstand these working operation states (provided that pre selection of the belt meets the operating criteria). The design life of the belt will be met and usually exceeded provided that no other forces other than the above act upon the belt during its operating life. Forces such as , Misalignment and Loose or Overtight belt tension are killers of flexible belt drives. Useful operating life can be reduced by as much 80% by poor pulley alignment. In addition to belt wear, pulleys, bearings and seals additionally are damaged by inattention to basic installation requirements

### **Belt Tension**

The required tension of newly installed belts is virtually always specified by the belt manufacturers, this should always be followed meticulously.

## Alignment of Pulleys and Sheaves

If there is no specification then a guide to belt tension as follows can be applied :-

Tension load = The distance in cm between the axes of the driver and driven shafts x 1.0 mm

max deflection = 1 mm per 100 mm  
of total pulley center distance

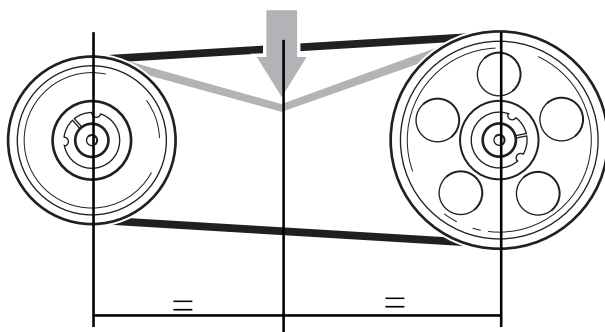

After tensioning and alignment re-start the machine, after a running period of 48 hours the tension on the new belts should be re-checked and re-tightened to correct any mid span deflection that exceeds the tension specification.

It is advisable to use a custom designed belt tension testing device for accurate and repeatable measurement of belt tension, periodic checking of each belt drive will quickly identify any drives that need tightening (or loosening) before incipient damage to the belts and other components cause premature failure.

# Alignment of Pulleys and Sheaves

---

## Pulley Alignment.

By far the most common and damaging installation error that occurs on belt drives is that of misalignment of the driving and driven pulleys. This is not usually due to carelessness on the part of the installer, it is more often due to a lack of suitable tools with which to carry out the required alignment. For many years at best a tight wire or straight edge were the only available tools with which to do the job.

Both methods rely entirely on the installers eyesight to ensure that the alignment is correct. Neither methods have any measurements documented, both rely upon the installer adjusting the driven pulley until the faces or grooves of the driven pulley touch the surface of the straight edge or tight wire. The driven pulley is then rotated half a turn and then rechecked and adjusted. The measurement is then repeated until the pulleys appear to be in line. No angularity or inaccurate mounting of the reference line is measurable. The system is purely an estimate of the alignment of the two pulleys.

## Types of pulley misalignment

There are three basic parameters that describe pulley misalignment. These are Vertical angularity, horizontal angularity and axial offset. These



Horizontal  
angularity



Vertical  
angularity



Axial  
offset



## **Alignment of Pulleys and Sheaves**

---

conditions usually occur in any or all combinations of alignment condition.

### **Pulley Run Out**

In addition to correct alignment of the pulleys, the run out errors of the pulley should also be measured and corrected. The two types of run-out - rim (radial) and face (axial) should be corrected until they meet tolerance before final alignment of the pulleys takes place.

If this is not corrected the effect could be that the belts slacken off at one position and then snap into tension at the opposite position.

This continuous snapping action if not corrected quickly wears out belts and bearings.

The tolerance for radial or rim run-out on high speed pulleys (1500rpm and higher) should not exceed 0.12 mm ( 0.005 inches) total indicator reading (T.I.R.) on average, and may be increased up to 0.24mm (0.01 inches) on slower pulley drives.

The tolerance for axial or face run-out should not exceed 0.05mm per 100 mm (0.0005 per inch) of pulley diameter for high speed pulleys, and may be increased up to 0.1 mm per 100 mm (0.001 per inch) of pulley diameter for slower pulley drives.

Check that the offset from the pulley mounting face to the groove is the same for both pulleys.

The pulley or machine manufacturers tighter tolerance recommendations should be followed where possible. Start by checking for radial run-out if unsatisfactory, check for shaft run-out. If excessive run-out is present on the shaft it may be bent and must be replaced before radial run-out on the pulley is checked again. If no shaft run-out is detected replace the pulley instead. If the pulley is mounted on a tapered shaft bushing, inspect and clean the bushing both inside and out to ensure proper seating.

Now check for face (axial) run-out and if necessary correct it by repositioning the pulley on its shaft. When run-out is in tolerance proceed to install new belts.

# **Alignment of Pulleys and Sheaves**

---

## **Drive Belt fitting**

Clean pulleys of all foreign matter with a stiff brush, (not a wire brush as this can damage the surface of the groove walls). Use the “go-no-go” profile gauges that can be obtained from the belt manufacturer to ensure the pulley condition is acceptable for the fitting of new belts. Replace any pulleys with worn, chipped or cracked groove surfaces.

Install new belts on the pulleys so that the slack sides of all belts are on the same side at either top or bottom of the drive. **DO NOT UNDER ANY CIRCUMSTANCES** install belts by prying them onto pulleys by any forcible method, belts should be fitted by hand pressure only. De-tension the motor to allow this fitting to be effected without undue pressure.

In the case of multiple belt drives when replacing belts, even where only one belt appears worn all belts should be replaced together. Only belts from the same manufacturer should be combined together, preferably a factory matched set.

After replacing belts it is worth examining the replaced belts for noticeable defects such as cracking or glazing. The condition of the belt is a good indication of the type of installation problems

Uneven wear or cracking on belt sides are a good indication of misalignment, glazing on the contact surface of the belts indicate slipping and therefore poor belt tension.

## **Checking Soft Foot**

Having mounted the belts and positioned the driver and driven units in their approximately correct position a check on the soft foot condition of the moveable machine (usually the driver) is useful. Undetected soft foot can lead to distortion of the machine frame when bolted down, causing damage to bearings, seals and higher than acceptable vibration on machine bearings.

To check for soft foot use feeler gauges under each machine foot in turn. (Or a DTI mounted on a magnetic base). Loosen each foot in

## Alignment of Pulleys and Sheaves

---

turn, measure any rise in the loosened foot and record it. Tighten the foot down and proceed to the next foot. Refer to pages 33 to 35 in this book for types of soft foot which can be present.

Having established the type of soft foot (if any) shim as necessary and re-check each foot. As a guide no reading of soft foot should be larger than 0.05 mm (0.002 inches).

### Pulley Alignment

Having completed the soft foot check the drive is ready for alignment, what ever system is employed for this be it tight wire, straight edge or laser system ( a brief description of this type of alignment will follow) the alignment should be as accurate as possible.

The nominal recommended tolerance for belt drives is 0.5 degrees. Most major belt and pulley manufacturers specify this value. Better tolerances can be achieved if the alignment procedure is carefully followed. The table below converts the tolerance from degrees into offsets in mm per 100 mm and in thousandths of an inch per inch.

Angle of misalignment	offset mm /100 mm	offset thous / inch
0.1°	0.18	0.00175
0.2°	0.35	0.00349
0.3°	0.52	0.00524
0.4°	0.70	0.00698
0.5°	0.87	0.00873
0.6°	1.05	0.01047
0.7°	1.22	0.01222
0.8°	1.40	0.01396
0.9°	1.57	0.01571
1.0°	1.74	0.01745

note - values between 0.1° and 0.5° fall within recommended tolerances
---

## **PULLALIGN<sup>®</sup> Laser Pulley alignment**

---

The PULLALIGN<sup>®</sup> system comprises two compact measurement units, a laser and a reflector system both with magnetic mounts to enable mounting onto pulley faces. Each unit is marked with a series of graduation lines to enable fine adjustment of the moveable machine in order to correct vertical and horizontal angular misalignment and axial offset.

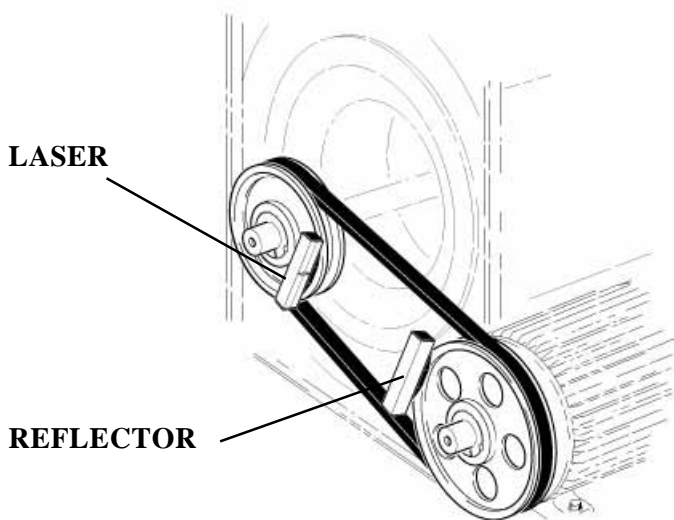

The laser sender transmits a laser line onto the reflector mounted on the opposite pulley, (the laser sender should be mounted on the stationary machine), depending on alignment condition the laser line will be shown clearly on the reflector and also will be transmitted back to the laser sender. The reflector indicates any vertical angularity that is present and simultaneously shows the amount of axial offset. The laser sender shows the horizontal angular condition of the drive.

The diagrams on the following page show typical displays of misalignment condition.

# PULLALIGN<sup>®</sup> Laser Pulley alignment

## Laser Line on the Reflector unit

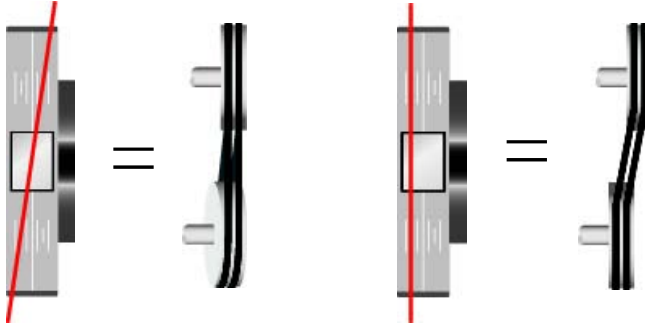

Observed Vertical  
angularity

Observed Axial  
offset

## Laser Line on the sender unit

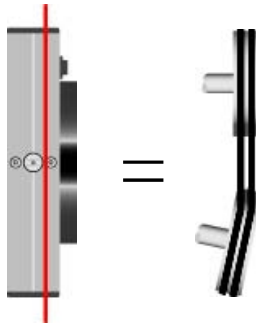

Observed Horizontal  
angularity

# PULLALIGN<sup>®</sup> Laser Pulley alignment

---

## Laser Line on the sender and Reflector units following alignment correction

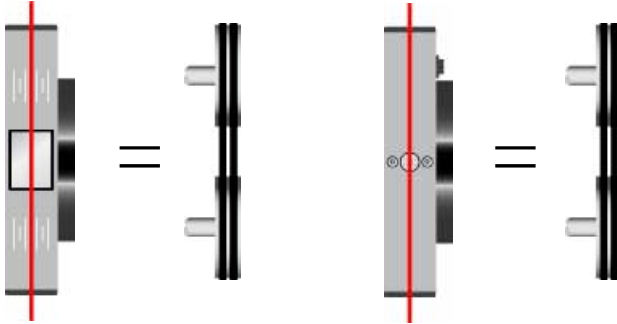

### Correction procedure

- 1 Correct vertical angularity by shimming the movable machine - this can often be achieved by shimming (or removing shims) from the rear feet of the moveable machine only. The corrections can be viewed on the reflector during adjustment.
- 2 Correct horizontal angularity by adjusting the moveable machine laterally. This can be viewed on the laser sender during adjustment.
- 3 Correct offset by adjusting the moveable machine axially, this correction can be observed on the reflector unit whilst adjustment is in progress.

By following the three steps described above the alignment of the pulleys should be quickly effected. When you are satisfied that the alignment is correct it is then necessary to properly tension the belts in accordance with the manufacturers tolerances (see page 76). Leave the PULLALIGN system in place during tensioning of the belt, this will give a clear indication of any changes to the alignment condition of the drive. If adjusting tension has changed the alignment condition make adjustments as required by following steps 1 through 3 described earlier.



# VIBXPert® II

**super fast FFT analysis, data collection and balancing system**

now with a superb  
high resolution  
colour screen

VIBXPert®  
is versatile:

- 1 or 2 channel
- FFT analysis
- Time signal analysis
- Orbit analysis
- In built ISO stds
- Visual inspection data
- In built brg database
- Dynamic balancing



The attractive external design of VIBXPert® is also reflected in its internal structure: intuitive graphical user interface, straightforward user guidance and constantly available help function allow not only skilled experts but also inexperienced novices to quickly achieve useable results



---

# Section 2 Vibration Analysis

# Conditon Monitoring

---

Most people involved in plant maintenance have heard of Condition Monitoring (CM). By definition CM means to periodically view machine operating condition and when necessary respond to any changes in machine condition. CM can be carried out by a number of “maintenance functions;” visual inspection, wear debris analysis, thermographic analysis and vibration analysis are the most popular methods used in the UK. In this handbook we are concerned with the use of vibration analysis to measure, monitor and analyse machine condition.

Later we will look at vibration measurement techniques and explain some of the basic parameters and terminology that is used for machine condition measurement. Before this however it is useful to briefly look at the benefits that a CM regime can bring to an operating plant.

In 1988 the DTI reported that companies who have implemented a CM program on their plant on average spend 25% less on maintenance of the plant than companies who have no CM program.(1)

Given that a moderately sized UK plant will spend £250,000 annually on plant maintenance a saving of £62,000 plus additional savings on production, power and ancillary activities represents a very good return on the investment in a CM program.

If the returns on an investment on a CM programme are so good why doesn't every plant have a system in operation? Most often the answer to this lies in a lack of understanding of what is required for CM on the plant, and on a fear that the cost of implementing a system and running it will be more than the return on cost that the system will realise.

Condition monitoring essentially means that the machines on plant get a “regular health check.” This is usually taken in the form of periodic vibration measurements. These measurements are compared to a standard or “known” operating condition, in the case of vibration this standard is usually an ISO norm or in some cases an on plant standard

*(1) DTI Boardroom report on maintenance in British Industry 1988.*

## Conditon Monitoring

---

or manufacturers recommendations. By making a comparison between current condition and “ standard or known” condition an evaluation can be made as to whether the machine operating condition has changed. Depending on the extent of change the machine condition can be further investigated or monitored more frequently to detect further changes. The key tool in this CM concept is to trend collected data and respond to changes in the trend. The objective is to intervene before the machine fails catastrophically.

### **The “Nuts and Bolts” of a CM system**

Having identified the basic principle of a CM regime, what are the costs of getting a programme up and running? The answer is, not much. A system can cost as little as a few hundred pounds for a simple portable “point and shoot” product that is touched onto the machine and gives a reading of vibration severity, (usually RMS vibration), this reading can be manually recorded on a chart. Readings are then compared over time to identify a change in measured operating condition. A development of this is to collect machine condition data and input this into a PC program to automatically establish and trend machine condition data. Further developments allow analysis of machine condition via algorithmic calculations (FFT analysis) to determine specific machine condition defects. From hand portable systems you can progress to fixed or on line monitoring systems which provide round the clock measurement and alarming of machine condition.

As system complexity and analysis capabilities expand so does system cost, normally the criticality of machines to the operation of the plant will determine the level of monitoring system required on the plant. It does not follow, however, that a company who spends £20,000 on a CM system gets a 20 times better system than a company who spends £1,000, or will get 20 times better CM results.

Take the CM route that is most comfortable. Match the system to the plant, and to the skills available. Don't go for the most expensive system option just because a salesman says it is the best, it may be, but, it may not be appropriate to the plant.

# Conditon Monitoring

If the plant has many process critical machines on-line monitoring may need to be considered. If the process plant is small, start simple, routine visual inspection and simple overall vibration readings will suffice. If in doubt, irrespective of plant size, start simple. Provided the system implemented is capable of expansion and can grow as CM requirements grow, you need not worry about more complex analysis capabilities. Trend the data collected - most systems (even the most expensive) trend the data and only analyse when a problem occurs! If necessary outsource the analytical expertise required.



*A typical low cost portable CM system - Vibrotip*

## **Implementing a CM programme.**

First and foremost implementing a CM regime means that you have to know your plant, a basic understanding of the way the machines behave and the way they should behave is essential. This doesn't mean extensive initial investment in sensors, expert analysis or highly skilled personnel. Information from ISO standards, machine suppliers and past plant operating experience will often provide the information required to initially establish how the plant **should** behave. How the plant **actually** behaves can be established by a combination of techniques including vibration measurement, thermography, oil analysis and operator experience of the plant.

# Conditon Monitoring

---

One of the keys to running an effective CM regime is the investment that the plant management is prepared to make in ensuring operators are skilled in using the systems they employ, and that on going training is available to maintain operator skills.

Implementing and maintaining a CM regime doesn't have to be a full time job; but it does require commitment and regular monitoring routines via some form of data acquisition, storage and regular review.

## **Returns on CM investment.**

The most effective prevention of machine breakdown is a combination of regular data acquisition, trending analysis and root cause analysis and machine operator awareness. Attention to changes in operating condition, a leaking seal, an increase in overall vibration, a change in machine operating temperature or even an increase in operating noise will notify an alert operator or engineer of a potential problem. It doesn't mean you shut the plant, what it should mean is that you investigate further, eliminate variable process changes and then increase frequency of monitoring of the machine to establish the rate of change in operating condition. (A rapid rise requires intervention quickly before plant failure, a slow rise means that you can plan a convenient future time for intervention).

This then is one of the principle benefits of implementing CM on your plant.

- It allows your engineers to plan plant shutdown; pre order spares and get the right personnel available to carry out the shutdown work.

Everyone who has been involved in maintenance or production using process plant will have experienced a "sudden" plant failure. A bearing on a pump for example seizes, the catastrophic result is a mechanical seal is destroyed, product spills, a shaft or coupling is destroyed. If you can reduce or eliminate these "sudden" failures and intervene before

## **Conditon Monitoring**

---

catastrophic failure only the failing component (in this case the bearing) has to be replaced.

- CM will help prevent ancillary plant damage thus the cost of replacement parts will be lower, and time to effect repair will be less - plant will restart quicker.
- Labour costs can be reduced by focussing the work force on problem areas.
- A proven CM routine should enable you to negotiate better plant insurance rates.
- You can “push” process machines harder to gain extra production if needed whilst monitoring plant condition.
- You can reduce or eliminate routine machine shutdown.
- You can build production reserves prior to a forecast machine shut down in order to eliminate production losses.

The common denominator of all these benefits is cash. Improved process plant availability, and reduced maintenance costs effectively mean a more profitable production plant.

Having reviewed the options available and the CM strategies that you can adopt, you should sit back and ask what you really want out of a plant improvement scheme. You may just want a quiet life, or to improve machine reliability or you may want to improve plant-operating profitability. What you want will dictate what you are prepared to spend and commit to CM. Whatever the reasons for the investment, CM will repay you long after the cost of equipment has been capitalised and written off in your accounts.

# Why Vibration Analysis?

---

## **Vibration Data has high information content.**

Vibration measurements contain a lot of useful information that will help determine the health of the machine for example:

- It provides information for safe machine operation.
- It can detect that the condition of a machine has changed.
- It can be used to diagnose the cause of change.
- It can be used to classify the condition of a machine.

Vibration measurement is normally a non intrusive measurement procedure, it can be carried out with the machine running in its normal operating condition.

Vibration is an effect caused by machine condition.

# Vibration analysis - Basic parameters

---

## What is Vibration?

Vibration is simply the oscillation about a reference point (i.e. a shaft vibrates relative to the casing of a piece of machinery and a bearing vibrates relative to a bearing housing.) Vibration exists when a system responds to some internal or external excitation and can be broken down into 3 basic types.

### 1 Free Body vibration

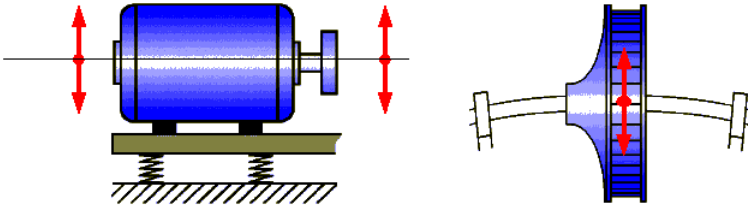

### 2 Meshing and passing vibration

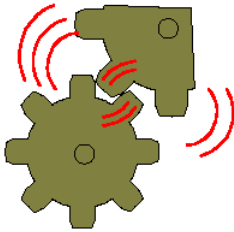

Gear mesh vibration

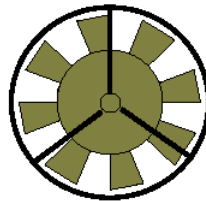

Blade pass vibration



# Vibration analysis - Basic parameters

## 3 Frictional vibration

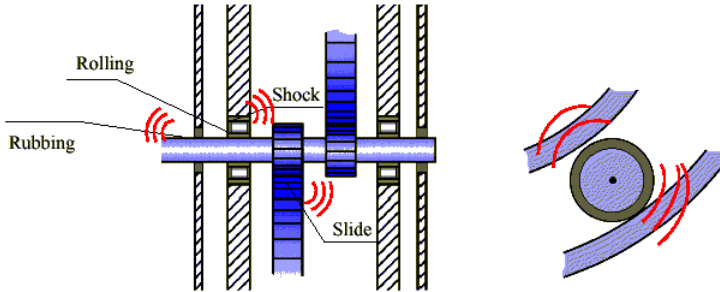

The amplitude of vibration depends on the magnitude of the excitation force, the mass and stiffness of the system and its damping. Vibration occurs because we are not able either to build a perfect piece of machinery or to install it perfectly. If we could build a perfect piece of machinery, the centre of mass of the rotating element would be located exactly at its centre of gravity. When the centre of mass and centre of gravity do not coincide the rotor has a heavy spot and some degree of unbalance. This unbalance produces a vibration proportional to the amount of weight of the heavy spot. Additional sources of vibration are machine tolerances, machine structure, bearing design, loading and lubrication, machine mounting and rolling and rubbing between moving parts.

The analysis of vibration requires an understanding of the terminology used to describe the components of vibration.

### Frequency

The cyclic movement in a given unit of time. The units of frequency are:

RPM = revolutions or cycles per minute.

Hertz (Hz) = revolutions or cycle per second.

# Vibration analysis - Basic parameters

These are related by the formula:

$$F = \text{frequency in hertz} = \text{RPM}/60.$$

## Amplitude

The magnitude of dynamic motion of vibration. Amplitude is typically expressed in terms of either

Peak to Peak: 0 to Peak: RMS (Root Mean Square).

The sketch below illustrates the relationship of these three units of measurement associated with amplitude.

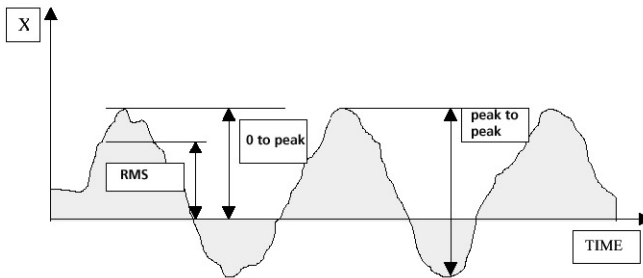

Amplitude, whether expressed in displacement, velocity or acceleration is generally an indicator of severity. Since industrial standards of vibration severity will be expressed in one of these terms, it is necessary to have a clear understanding of their relationship. Care must be exercised to note the “type” of amplitude measurement when comparing machinery vibration to industry standards.

## Fundamental Frequency

Fundamental frequency is the primary rotating speed of the machine or shaft being monitored and usually referred to as the running speed of the machine.

# Vibration analysis - Basic parameters

You will also see the fundamental frequency referred to as 1 x RPM, or as Hz, using as an example an 1800 RPM motor this would be 30Hz ( $1 \times 1800/60$ ). The fundamental frequency is important because many machinery faults such as misalignment or unbalance occur at some multiple of the fundamental frequency, for example misalignment at 1 x fundamental frequency.

## Harmonics

These are the vibration signals having frequencies that are exact multiples of the fundamental frequency (i.e.  $1 \times F$ ,  $2 \times F$ ,  $3 \times F$  etc.).



Time signal

Spectrum

## Displacement (D)

Displacement is the actual physical movement of a vibrating surface. Displacement is usually expressed in mils (thousands of an inch) or microns. When measuring displacement, we are interested in the Peak to Peak displacement which is the total distance from the upper limited to the lower limits of travel.

## Velocity (V)

Velocity is the speed at which displacement occurs. We define velocity as the rate of change in the relative position. Velocity is usually measured in mm/sec RMS, or inches/sec RMS.

# Vibration analysis - Basic parameters

## Acceleration (A)

Acceleration is the rate of change of velocity. This we can simply define as the change of velocity in a period of time or change in rate of velocity. Acceleration is usually measured in g's of gravitational force.

## Vibration frequency spectrum

Machinery vibration consists of various frequency components as illustrated below. The amplitude of each frequency components provides an indication of the condition of a particular rotating element within the machine.

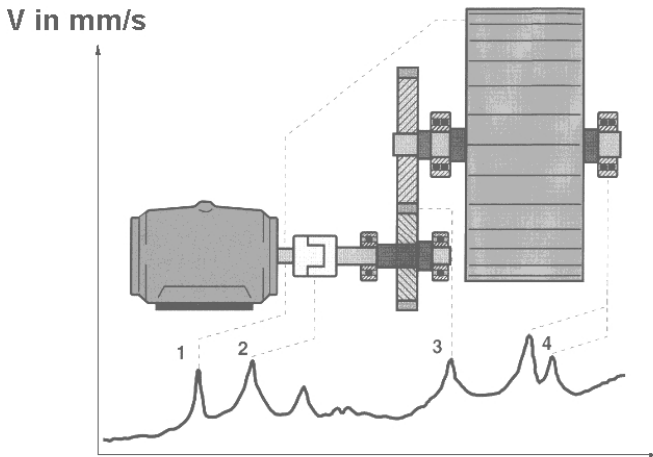

Simply stated, a vibration frequency spectrum converts a vibration signal into a true amplitude representation of the individual frequency components. Since most machinery faults are displayed at or near a frequency component associated with running speed the ability to display and analyse the spectrum as components of frequency is extremely important.

# Vibration analysis - Basic parameters

The advantage of frequency spectrum analysis is the ability to normalise each vibration component so that the complex machine spectrum can be divided into discrete components. This ability simplifies the analysis of mechanical degradation within the machine. The chart shown below illustrates typical signal forms for various machine components.

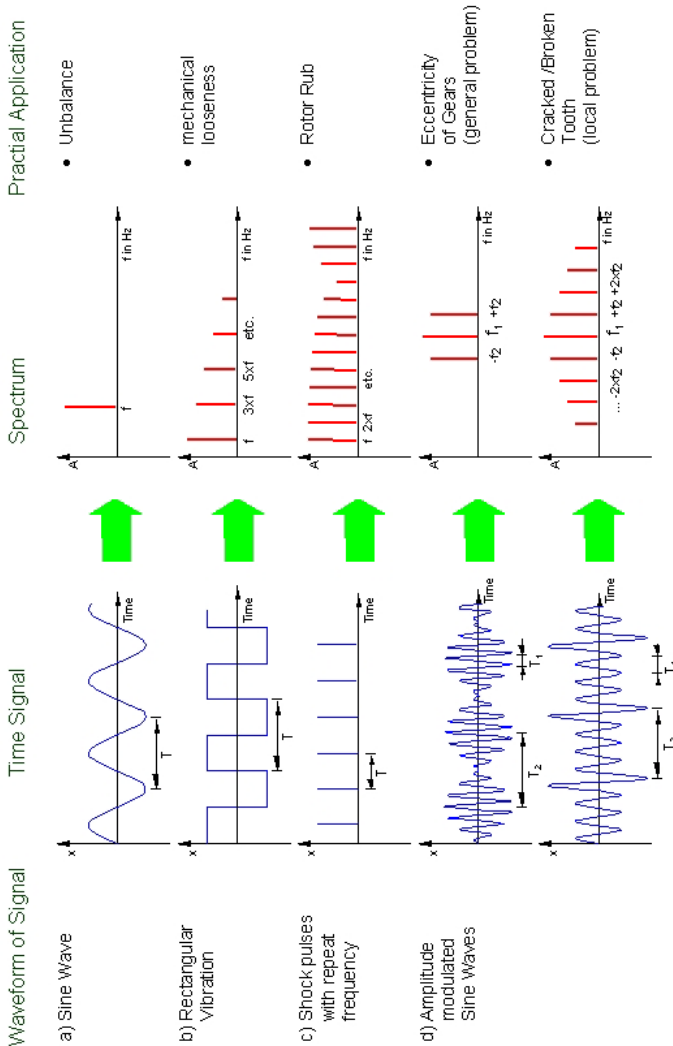

# Vibration analysis - Basic parameters

## Relationship between Displacement, velocity, amplitude and frequency.

Variation in the values of velocity and acceleration with frequency is extremely important, for it forms the basis for vibration severity criteria, provides guidelines for selecting the variable which will be most representative for a particular purpose, and explains how failures can occur without warning if the wrong variable is monitored. It's variation is best illustrated by plotting displacement and acceleration verses frequency at a constant velocity amplitude of 7 mm/s as shown below.

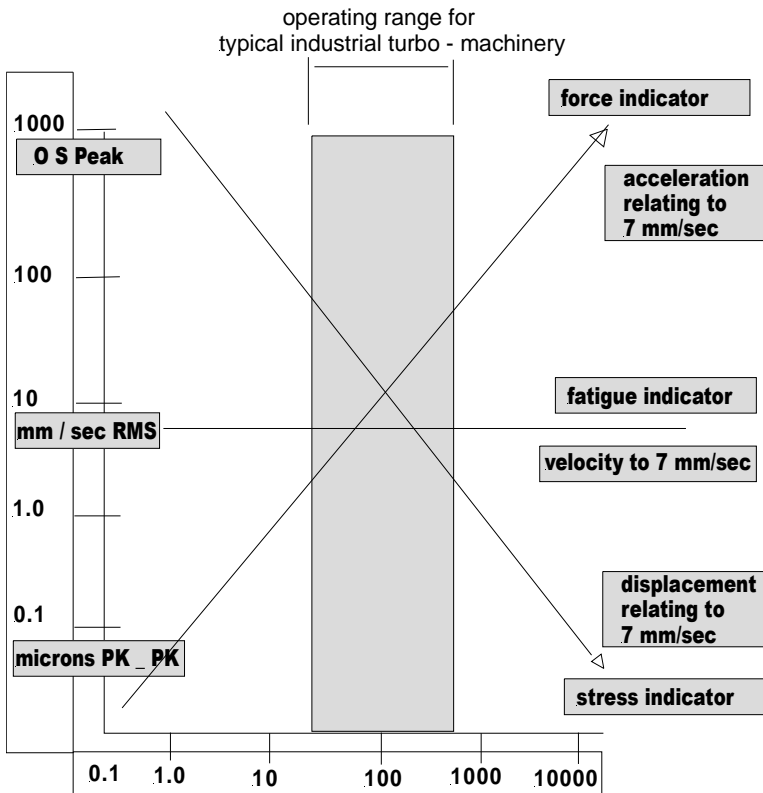

## **Vibration analysis - Basic parameters**

---

Note that velocity appears to be a valid indicator of condition across the entire range of frequencies. This is the main reason why vibration is used as the prime indication of mechanical condition.

The relationship between displacement, velocity and acceleration also provides the best indication of which parameter should be measured to assess condition. The diagram clearly shows that when examining the low frequencies around or below the running speed of most machinery, displacement or velocity measurements are likely to produce the best quality signal. On the other hand, phenomena such as bearings resonance's at 5-10KHz and above, are best measured in terms of acceleration.

### **FFT (Fast Fourier Transform)**

FFT is predominantly the most used tool in analysis of spectral data with respect to vibration analysis of machine components. Fourier transform is a mathematical operation which decomposes a time domain function into its frequency domain components.

# **Vibration analysis - transducers**

---

## **Transducer location**

The position and the manner in which data is collected is very important to a successful vibration monitoring programme. In order to properly diagnose a fault, data must be collected in the right plane and must be repeatable. Some faults show the high amplitude in the radial direction and some in the axial direction.

Measure location should usually be on exposed parts of the machine that are normally accessible and that reflect the vibration of the bearing housing. Vertical and horizontal mounting directions are the most usual transducer locations for horizontally mounted machines, any angular position is acceptable provided that the location reasonably represents the dynamic forces present in the machine. For vertically mounted machines the location giving the maximum vibration reading should be used as a future monitoring reference point

The data collection points should be clearly marked to ensure that data is collected at the same point every time. (Frequently, measurement studs are permanently fixed to the machine ensuring reproducibility of measurement location). When analysing a machine for changes, the analysis can be inaccurate if data is not collected at the same point each time.

Measurements should be carried out when the rotor and main bearings have reached their normal steady state operating temperature, speed, load, voltage and pressure. Where machine speeds vary measurements should be taken at all conditions at which the machine operates for a prolonged period.

## **Transducer design**

There are a variety of instruments (transducers) that will convert actual mechanical movement (vibration) into electrical energy.



# Vibration analysis - transducers

## The industrial Accelerometer

Accelerometers are the most widely used transducer in routine vibration monitoring programmes. A typical accelerometer contains a piezoelectric crystal element which is pre-loaded by a mass of some type and the entire assembly is enclosed in a rugged protective housing. The piezoelectric crystal produces an electrical output when it is physically stressed by either a pressure or tension effect as shown below.

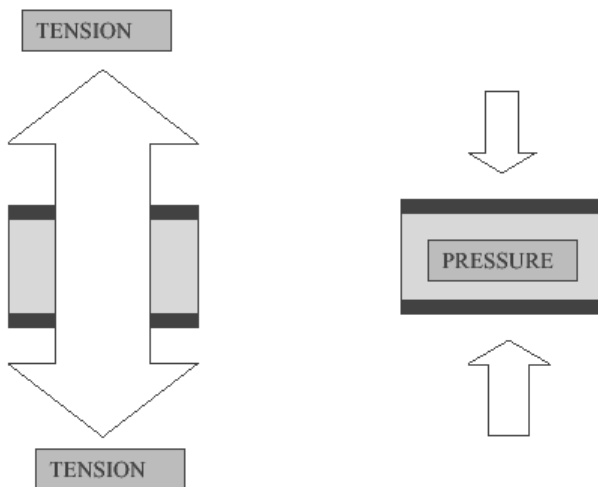

The variable vibration force exerted by the mass on the crystal produces an electrical output proportional to acceleration. Accelerometers have a broad frequency range typically from 2Hz to 10KHz the accelerometer is also easily mounted, either with a stud, a magnet, adhesive or by hand-holding the device onto the machinery surface. Accelerometers also have good temperature and environmental responses and are usually of a rugged construction

# Vibration analysis - transducers

## Accelerometer frequency response.

Each accelerometer has a usable frequency range and response curve typically as shown below. If the data to be collected is outside the frequency range shown on the response curve, an accelerometer having the correct response should be chosen. As a general rule, the smaller the accelerometer, the higher the usable frequency range.

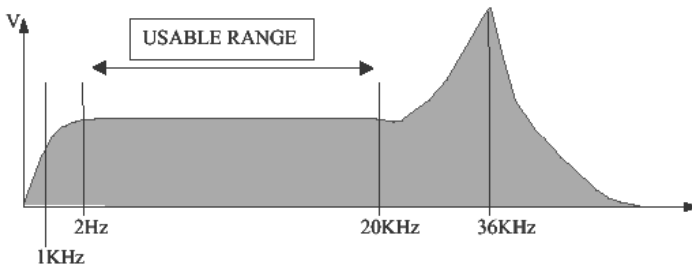

*Typical accelerometer response for threaded or bonded transducers.*

## Accelerometer mounting.

The mounting of an accelerometer plays a significant role in its frequency response. Shown below are four different types of mounting methods for transducers, all of which are used in vibration analysis programmes.

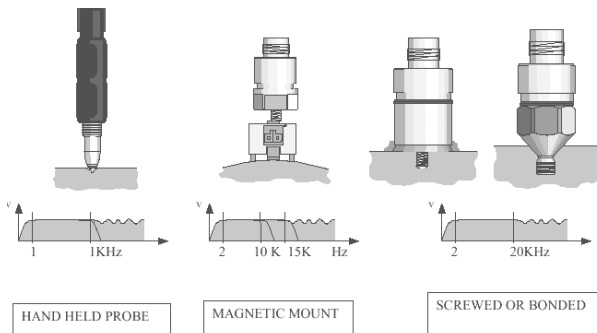

# Vibration analysis - transducers

The screw or stud mounted unit with the proper accelerometer has a frequency response of around 20KHz, the epoxy mount (glue mount) gives approximately the same response, the permanent magnet to approximately 5KHz and the hand held unit typically around 1.5KHz. The more rigid the transducer contact with the machine the better the frequency response and hence the better the reliability of the vibration reading.

## Signal Processing

The raw data collected by the transducers must be enhanced to provide useful information. For vibration data this raw data must be “conditioned” to prevent errors. Typically such conditioning includes:

- Filtering to remove unwanted or spurious signals
- Amplifying to enhance the resolution of low energy signals
- Data averaging to remove spurious data
- Conversion to frequency domain (FFT).

To assist with these filtering techniques many analysers provide a number of “window” functions which, depending on the type selected, will assist with analysis of data.

### Rectangular Window

This provides for higher inaccuracy in the amplitude domain but with a greater accuracy in the frequency domain. A practical use for this window is for transient process e.g. bump tests to identify natural component frequencies.

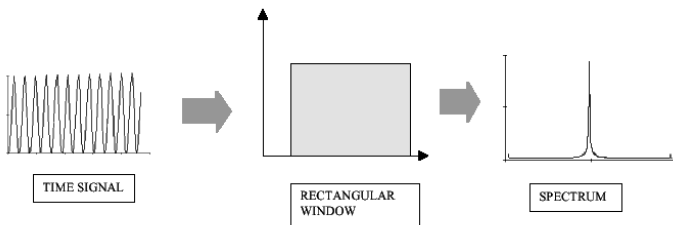

# Vibration analysis - transducers

---

## Flat top Window.

This has the highest accuracy for the amplitude domain but higher inaccuracy for the frequency resolution domain

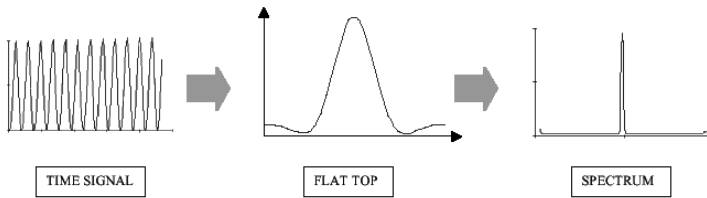

## Hanning Window.

This is the standard window for most vibration analysis, it has the best accuracy for the frequency resolution domain, but with higher inaccuracy in the amplitude domain.

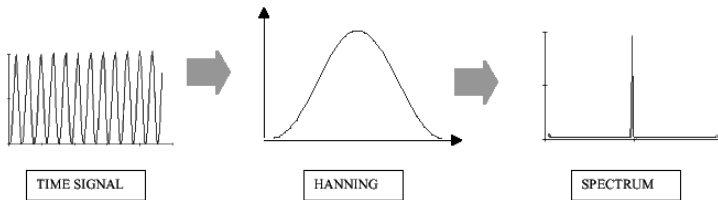



# **Vibration analysis - Fault Detection**

---

The chart on the previous page shows 4 zones of vibration severity ranging from good to unacceptable as follows:

- Zone A – the vibration of newly commissioned machines would normally fall into this zone.
- Zone B - machines with vibration within this zone are normally considered acceptable.
- Zone C – machines with vibration in this zone are normally considered unsatisfactory for long term continuous operation. Machine may be operated for a limited period in this condition until a suitable opportunity arises for remedial operation. (It is advised to increase the frequency of vibration monitoring during this operating period)
- Zone D – vibrations within this zone are normally considered to be of sufficient severity to cause damage to the machine.

The use of these zones and the numerical values ascribed to them are not intended as an acceptance standard for machine manufactureres and customers but the values do help to establish alarm and warning criteria for a routine condition monitoring program. If machines are found to be operating at vibration levels consistantly above the nominal values shown in the standard, investigation as to the cause should always be carried out.

2 Comparison to previous readings is the most widely used method of identifying changes in machine operating condition. Most commonly referred to as trending, comparison quickly shows the machine operator or manager if the machine condition has changed, by how much and in what period of time. Trended graphical measurement values combined with ISO alarm limits give clear visual warnings of machine condition change and with some software packages, can be used to predict likely run to failure intervals in order to schedule remedial repair. (Graphic predictions of machine trends should always be considered as a guide to likely failure and not as a definitive measurement of machine failure intervals).

# Vibration analysis - Fault Detection

---

## Fault Mode analysis.

There is a great deal of literature on diagnostic techniques employed for various types of equipment. Although we will not discuss specific diagnostic methods in this handbook, you will find that a great deal of information must be readily available to execute an effective vibration monitoring programme. Once the vibration monitoring programme flags a machine as potentially having a mechanical problem, everyone will immediately want to know:









- How severe is the problem?
- What is the problem?
- When must the machine be taken out of service for repair?

Machinery diagnostics using vibration analysis provides information that addresses these questions.

The machinery diagnostics technique viewed here is based on a technique known as “fault mode” analysis. This technique utilises the fact that specific mechanical events, such as unbalance, misalignment, looseness, bearing defects, aerodynamic and hydraulic problems, and gearbox problems usually generate vibration frequencies in specific patterns. The frequency, amplitude and pattern of the peaks in a vibration spectrum can be a telling indication of the type of problem being experienced by the machine. The following chart summarising specific machinery faults and their vibration patterns. The principles of “fault mode” analysis include:

- Measurement of mechanical faults such as unbalance and misalignment generate mechanical vibration in a well defined frequency pattern.
- Comparing the vibration levels and vibration spectra on similar types of machines will help establish the severity and cause of a vibration problem.

## Vibration analysis - Fault Detection

<u>POSSIBLE CAUSE</u>	<u>DOMINANT FREQUENCY</u>	<u>DIRECTION</u>	<u>COMMENTS</u>
<b>UNBALANCE</b> 	1 x ROTATIONAL FREQUENCY.	RADIAL FOR DYNAMIC UNBALANCE, POSS –AXIAL.	VIBRATION AMPLITUDE PROPORTIONAL TO UNBALANCE & RPM, CAUSES SEVERE VIBRATION TO OCCUR.
<b>MISSALIGNMENT</b> 	2 x ROTATIONAL FREQUENCY.	RADIAL & AXIAL.	SEVERE AXIAL VIBRATION & 2 <sup>nd</sup> HARMONIC; BEST REALIGNED USING LASER i.e., ROTALIGN OR OPTALIGN PLUS.
<b>BEARING DEFECTS</b> 	HIGH FREQUENCY VIBRATION.	RADIAL & AXIAL. LOADED POSITION IF POSSIBLE	USING BEARING ENVELOPING DIAGNOSTIC TECHNIQUES, OR SHOCKPULSE TO DETERMINE DAMAGE SEVERITY.
<b>M/C FOUNDATIONS</b> 	TYPICALLY AT ONE OR MORE NATURAL FREQUENCIES (Transient Vib)	RADIAL	NATURAL RESONANT FREQUENCY OF FOUNDATION OR MACHINE BASEPLATE.
<b>BELT VIBRATION</b> 	ROTATIONAL FREQUENCY & MULTIPLES THEREOF.	RADIAL	ADDITIONALLY RECOMMEND USING STROBE TO COMBINE M/C RPM & BELT SPEED TO CHECK FOR BELT SLIPPAGE.
<b>BLADE PASS FREQUENCY</b> 	NUMBER OF VANES OR BLADES X FUNDAMENTAL FREQUENCY	RADIAL	VIBRATION FREQUENCY REPRESENTED BY THE NUMBER OF BLADES TIMES THE SHAFT ROTATIONAL FREQUENCY.
<b>ELECTRICAL</b> 	LINE FREQUENCY 50Hz (UK) 60 Hz (USA) & MULTIPLES THEREOF.	RADIAL & AXIAL	SIDE BANDS MAY ALSO OCCUR AT MULTIPLES OF THE ROTATIONAL FREQUENCY. VIBRATION CEASES WHEN POWER IS TURNED OFF.
<b>GEAR MESH DEFECT</b> 	GEAR FREQ. EQUAL TO NUMBER OF TEETH X ROTATIONAL FREQ OF GEAR IN QUESTION	RADIAL & AXIAL	THE SIDEBANDS OCCUR FROM MODULATION OF THE GEARTEETH MESHING VIBRATION AT THE ROTATIONAL FREQUENCY; e.g. THE INPUT & OUTPUT SHAFT SPEEDS OF THE GEARBOX.
<b>COMPONENT RESONANCE</b> 	NATURAL COMPONENT FREQUENCY	RADIAL & AXIAL	A COMPONENTS NATURAL FREQUENCY COINCIDES WITH A EXCITABLE FREQUENCY.



# Vibration analysis - Fault Detection

---



**Unbalance.** Vibration caused by unbalance occurs at a frequency equal to 1 RPM of the unbalanced part, and the amplitude of vibration is proportional to the amount of unbalance present.

Normally, the largest amplitude will be measured in the radial (vertical or horizontal) directions.

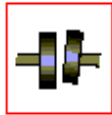

**Misalignment.** Generally, misalignment can exist between shafts that are connected with a coupling, gearbox or other intermediate drives. Three types of misalignment are:

- Angular - where the centre line of the two shafts meet at an angle.
- Offset - where the shaft centre lines are displaced from one another.
- A combination of angular and offset misalignment.

A bent shaft looks very much like angular displacement, so its vibration characteristics are included with misalignment.

Misalignment, even with flexible couplings, have two forces, axial and radial, which result in axial and radial vibration. The significant characteristics of vibration due to misalignment or a bent shaft is that it will be in both the radial and axial directions. For this reason when axial vibration is greater than one half of the highest radial measurement (horizontal or vertical), then misalignment or a bent shaft should be suspected.

All misalignment conditions will produce vibration at the fundamental (1 x RPM) frequency components since they create an unbalanced condition in the machine.

Misalignment will sometimes produce vibration at the second (2 x RPM) harmonic

# Vibration analysis - Fault Detection

---

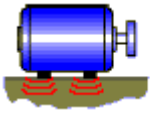

**Loosness.** Mechanical looseness can be caused by loose rotating components or loose machine foundations.

Mechanical looseness causes vibration at a frequency of twice the rotating speed ( $2 \times \text{RPM}$ ) and higher orders of the loose machine part. In most cases, vibration at the fundamental ( $1 \times \text{RPM}$ ) frequency will also be produced.

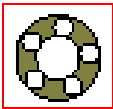

**Bearing Problems.** One of the results of damage to rolling element bearings is that the natural frequencies of the bearing components are excited by the bearing defect. The resonant vibration or “ringing” occurs at high frequencies ( $2 - 60\text{KHz}$ ).

This vibration is most effectively measured at a level of acceleration in units of g's Peak. Vibration is measured by the Machinery Monitoring System as a HFE (High Frequency Energy) measurement and gives an effective indication of the condition of rolling element bearings. Based on field experience, the shock pulse technique works well on motors and other quiet equipment, but care must be taken when using the technique on pumps and gearboxes, where flow, cavitation and tooth meshing can produce impulses which interfere with and mask the impacts produced by bearing defects.

Rotational frequencies related to the motion of the rolling elements, cage and races are also produced by mechanical degradation of the bearing. These frequencies are dependent on bearing geometry and shaft speed and can be found typically, in the  $3 - 10 \times \text{RPM}$  range and because of these reasons the “enveloping” method is the most widely adopted method of viewing specific bearing defects. This method of bearing condition evaluation and that of shock pulse analysis of bearing condition are reviewed in the following pages.

# Vibration analysis - Fault Detection

---

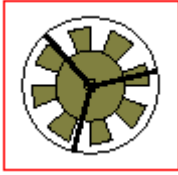

## **Aerodynamic and Hydraulic Problems**

Normally associated with blade or vane machinery such as pumps or compressors, aerodynamic and hydraulic vibration is created by an unstable or unbalanced condition within the machine.

In most cases this will produce a vibration at the fundamental frequency (1 x RPM) of the machine and blade pass/vane frequency components.

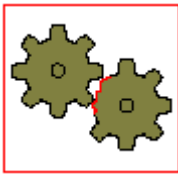

## **Gearbox Problems.**

Gear defects or faulty gears produce low amplitude, high frequency vibration. The vibration is predominantly at gear mesh frequency. Gear mesh frequency is calculated by multiplying the number of teeth in the output gear as follows:

Gear mesh frequency (GMF) = speed of output gear x number of teeth in output gear.

Example - 52 tooth gear running at 90 RPM ( $90/60 = 1.5$  Hz).

$GMF = 52 \times 1.5 = 78$  Hz.

Most gear problems exhibit vibration at the gear mesh frequency. Gear problems can be summarised as follows:

- Unbalance - predominant at the 1 x RPM of the gear.
- Misalignment - predominant at the 1 x RPM and 2 X RPM; may excite GMF.
- Pitch line run out - predominant at GMF with 1 x RPM sidebands.
- Faulty gear teeth - predominant at GMF with sidebands at 1 x RPM of faulty gear.

# Vibration analysis, Bearings- Enveloping

## Basic Theory of Enveloping.

When a bearing defect exists in a rolling element bearing the vibration signature will show high frequency vibration generated each time a damaged roller or damaged race make contact. These repetition rates are known as the natural bearing defect frequencies. In any rolling element bearing arrangement there are four types of element defect frequency.

Rolling element Passing defect Outer race Frequency. (RPOF)

Rolling element Passing defect Inner race Frequency. (RPIF)

Rolling element Passing Frequency. (RPF)

Cage Rotational Frequency (CRF)

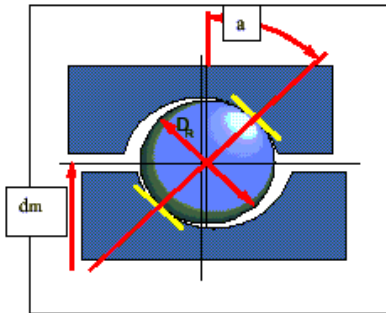
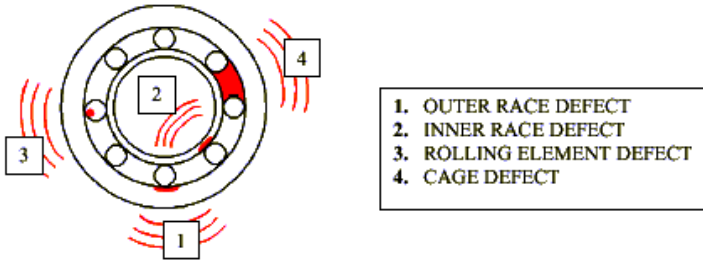

- a = contact angle
- Dr = Rolling element diameter
- dm = Bearing pitch diameter
- N = Number of rolling elements

# Vibration analysis, Bearings- Enveloping

**Formule for calculating bearing defect frequencies**

$$RPOF = N \times n / 2.6 \times (1 - DR \times \cos a / dm).$$

$$RPIF = N \times n / 2.6 \times (1 + DR \times \cos a / dm).$$

$$RPF = (dm \times n) / (DR \times 60) \times (DR^2 \times \cos a^2 / dm)$$

$$CRF = n / 2.6 \times (1 - DR \cos a / Dm).$$

**Example Pass Frequencies.**

Bearing type SKF 6211, operating speed 2998 RPM

<u>DIMENSIONS</u>	<u>DEFECT FREQUENCIES</u>
dm = 77.50mm	F = RPOP n / 60 . 4.0781 = 203.77 Hz
DR = 14.29MM	F = RPIF n / 60 . 5.9220 = 295.90 Hz
N = 10	F = RPF n / 60 . 5.2390 = 261.77 Hz
a = 0	F = CRF n / 60 . 0.4079 = 20.38 Hz

Enveloping is essentially a 2 stage process; the first stage is a band pass filtering of the time signal. The filtering process results in a series of spiky peaks when enveloping is applied to extract the repetition rate relating to the bearing defect and its harmonics as shown in the following frequency spectra. Since healthy rolling element bearings may exhibit vibration at the natural frequency of the bearing components it is very important to measure accurately the severity of bearing deterioration.

# Vibration analysis, Bearings- Enveloping

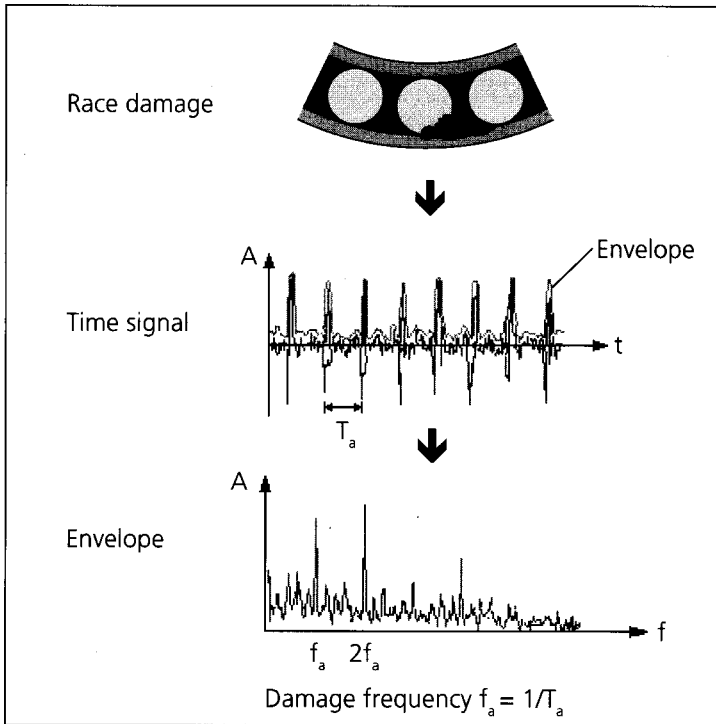

To measure the severity of a defect in an enveloped spectra the following must be undertaken.

Measure the amplitude of the specific component in dB (decibels) above the carpet value shown in the spectra.

The spectra above identifies the carpet and peak values. Experience tells us that when a bearing starts to deteriorate a peak to carpet difference of around 10dB can be seen. (this does not mean that bearing breakdown is imminent). As deterioration continues to show a

# Vibration analysis, Bearings- Enveloping

difference of around 15dB between peak and carpet levels the bearing should be monitored more closely and preparation made at some point to strip down the machine for repair.

When the defect amplitude is 20dB or greater immediate action should be initiated to repair and or replace the bearing.

The carpet level of the bearing should not be used as a stand alone method of monitoring bearing condition but should be used in conjunction with another trending technique such as shock pulse measurement.

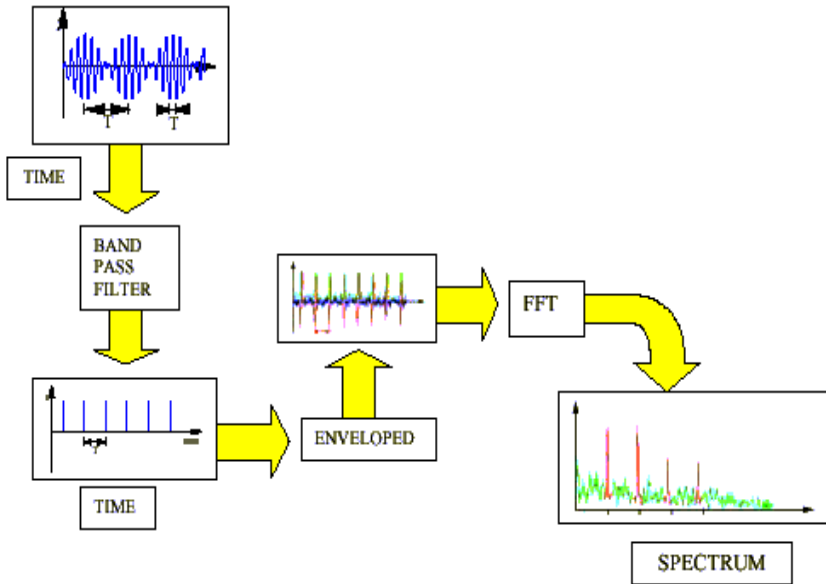

The above diagram shows the steps involved in obtaining an envelope spectra for a bearing.

# Vibration analysis, Bearings - Shock Pulse

## Shock Pulse measurement for bearing condition.

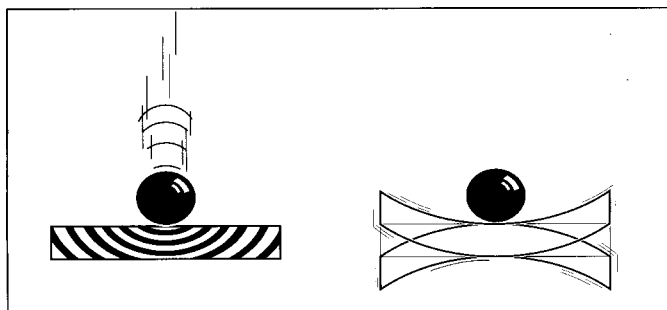

1 Shock pulse

2 Deformation wave

Of the non FFT methods used to assess the operating condition of anti-friction bearings, one of the most successful and popular techniques is that of shock pulse evaluation. Shock pulses are a special type of vibration which must be clearly distinguished from ordinary machine vibrations:

1. The actual shock pulse is the pressure wave generated at the moment when one metallic object strikes another.
2. The bulk of the impact momentum, however, acts to deform the target object, which then oscillates at its natural frequency. This vibration ultimately dissipates primarily as heat due to internal friction (material damping).

### Shock pulses in bearings

Shock pulses occur during bearing operation when a rolling element passes over an irregularity in the surface of the bearing race. Of course, there is no such thing as a perfectly smooth surface in real life, and so even new bearings emit a signal of weak shock pulses in rapid succession. This 'carpet level' rises when the lubrication film between rolling elements and their races becomes depleted.



# Vibration analysis, Bearings - Shock Pulse

A defect (pit or crack) on the surface of a rolling element or bearing race produces a strong shock pulse with up to 1000 times the intensity of the carpet level. These irregular peaks (the 'maximum value'), which stand out clearly from the background level, are ideal indicators of bearing damage.

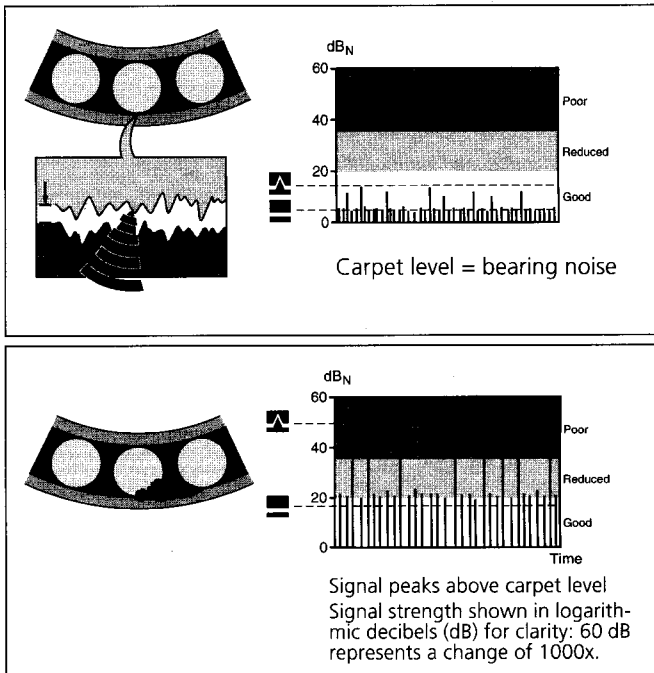

*Shock pulse diagrams of good and damaged bearings*

## Measurement

Shock pulses propagate within a much higher frequency range than that of ordinary machine vibration, and their energy content is much weaker. Therefore, the accelerometer used for shock pulse measurement has a resonance frequency (approx. 36 kHz) that lies precisely within this range.

## **Vibration analysis, Bearings - Shock Pulse**

---

This means that in this high frequency range of particular interest for bearing condition evaluation, the transducer is especially sensitive to the shock pulse signal - even when far more energetic machine vibration occurs at lower frequencies (for example, due to unbalance or shaft misalignment) or from adjacent machines. And since high-frequency signals tend to dissipate rapidly, very little interference is encountered from adjacent bearings.

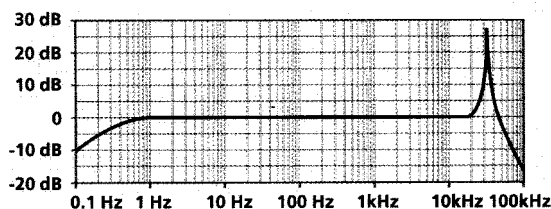

### **Evaluating bearing condition**

Just as with other condition evaluation methods, the shock pulse technique reaches its conclusions via certain defined parameters. These are influenced by factors such as bearing size, RPM, signal damping and lubrication, and so shock pulse readings generally should be compared with 'signature' readings (taken when condition is known to be good) or normalised to take these factors into account. Over the years reliable normalisation methods have been developed based upon extensive measurements, to calculate the effect of bearing size and RPM on shock pulse readings of new, perfect bearings. The normalised signal level (dBn) calculated for an actual bearing allows its condition to be rated directly as 'good', 'reduced' or 'poor'.

The validity of this statistical method is confirmed by a practical success rate of up to 90%.

# Vibration analysis, Bearings - Shock Pulse

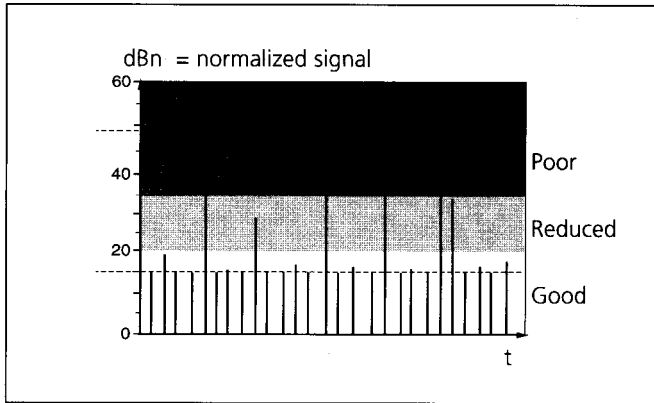

## Quantitative analysis

Two normalised parameters are used to determine bearing condition: the carpet value indicates deteriorating or poor operating condition (e.g. caused by insufficient lubrication, shaft misalignment or improper installation). Damaged bearing elements, in contrast, generate individual shock pulses of greater intensity. The resulting maximum value is a direct indication of bearing operating condition. Specific types of damage can be recognised not only from the absolute signal amplitude, but also from the difference to the carpet level and the pattern of pulses. Comparison with typical shock pulse diagrams often shows clearly where the problem lies. (e.g. 'lubricant contamination')

## Applications

The shock pulse method is suitable for use with all types of anti-friction bearings installed on rotating equipment (such as motors, pumps, turbines and compressors). When parameters are recorded at regular intervals, any deterioration in bearing condition can be recognised immediately.

# Vibration analysis, Bearings - Shock Pulse

The required maintenance procedures can then be planned and carried out with maximum efficiency, long before the bearing fails, bringing production to a halt along with it.

Bearing trends plotted over longer periods of time offer additional information on premature wear, improper installation and lubrication problems - or even improper machine operation (such as overloading) or defective machine parts.

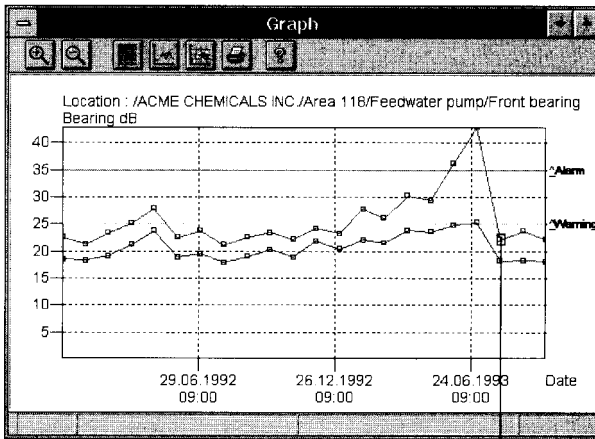

Lubrication

## Summary

Just as with any other method, the shock pulse technique will not guarantee infallible bearing evaluation, but can only deliver measurement values for comparison with known types of bearing damage. Twenty-five years of practical experience has shown, however, that its evaluation criteria have proven their reliability in practical use.

# **Vibration analysis - a common sense approach**

Most vibration problems respond well to a logical, systematic approach. A list of suitable steps towards firstly defining and secondly solving problems is given below:

## **RAW DATA**

1. Where is the vibration level highest on the machine and in which direction?
2. Is the vibration present in associated machinery and pipework or is it at highest levels on the bearing houses?
3. Do changes to the process and lubricating the bearings radically change the vibration response?
4. Does the trend show a roughly exponential growth with time?
5. How does the machine feel and sound in comparison with similar machines elsewhere?

## **DIAGNOSTICS**

1. Is this a new machine or one which has recently been worked on. If so, what could have been assembled wrongly and does this tie up with the raw data?
2. Which frequencies are dominant on the spectrum. Do these occur at gear meshing frequencies or low order multiples of shaft speed?
3. On rolling element bearings and gearboxes, how does the enveloped spectrum appear?
4. How quickly is the machine deteriorating and hence how soon does it need to be repaired? This includes consideration of capital worth of equipment, down-time and maintenance costs.
5. Vibration is usually highest at the point of maximum damage unless a resonant condition exists.
6. Vibration is usually the response of a machine to a fault so the only way to stop the vibration is to find the source not the response.
7. It is always necessary to build up several items of evidence before diagnosing a fault. The weapons available are HFE, spectra, envelopes, temperature and sound. For each fault the interaction and evidence from these will be different.

## **Vibration analysis - a common sense approach**

8. Vibration is a physical phenomenon and as such can be defined by physical means.

### **SOLUTIONS**

1. Where a fault has occurred on previously sound equipment it should be clear from the steps suggested above where the likely problem lies. Having defined the problem, the best course of action should be clear.

2. If the fault is on new or recently serviced equipment it may be unclear where the problem lies. Is something resonant? Is there a defect in the installation? Is there a basic design error? The solution to a problem of this type should be achieved in a logical manner. Try one solution at a time (starting with the most likely) taking new sets of data at each step. The best solution will gradually emerge.

3. Try to explain all the responses in relation to the damage found once the problem is solved.

# VIBXPERT Data collector and analyser

The vibration analysis functions and methods described in the previous pages can all be performed by the Pruftechnik VibXpert system, an overview of which is given in the following pages.

Essentially VibXpert is a modular system which can be configured to perform a number of vibration related tasks including

- Data collection
- 2 channel FFT analysis
- Time signal analysis.
- Dynamic Balancing

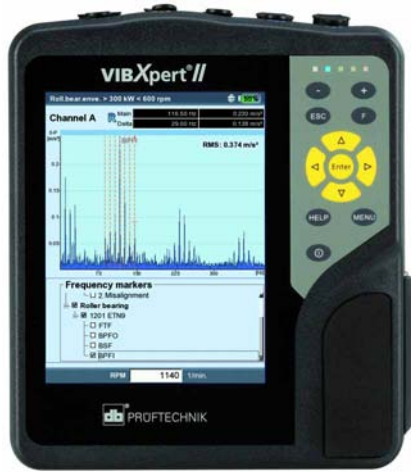

Depending on the user requirements and future plans the system can be purchased to meet immediate needs and added to as the user develops in experience or analytical requirements. In most instances the system is supplied with a dedicated software platform OMNITREND which allows for comprehensive machine analysis, trending, data archiving and reporting. OMNITREND is MS 95 + windows compatible, its data structure is compatible with both Oracle or Access database systems. VibXpert can also be used as a stand alone instrument, it features built in transducers for:

- Vibration measurement.
- Bearing analysis.
- Temperature measurement
- RPM measurement.

# VIBXPERT Data collector and analyser

Data trending for all of these parameters is also possible within the instrument, with active on screen data on value, time of measurement and, for vibration values, comparison with ISO standards.

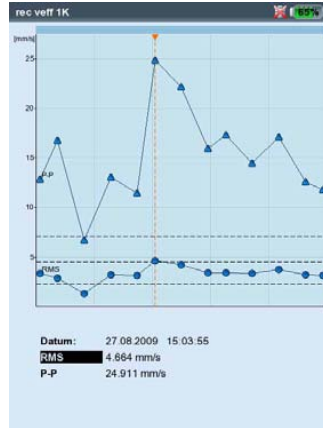

The VibXpert application program is graphic-oriented and menu-driven, clear visual displays prompt the user to take specific actions dependant upon the measurement task required.

When measuring machine condition in for example a routine data collection round, all machine data and measurement locations are shown on the instrument screen.

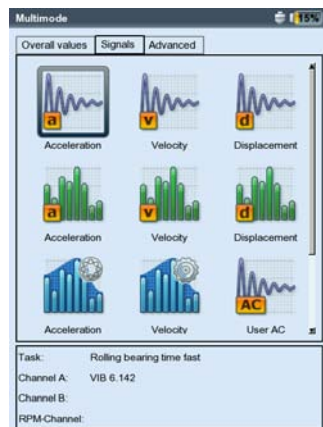





# VIBXPert Data collector and analyser



To compliment the features provided in the VibXpert the system has two unique methods of ensuring error free data collection and analysis of data. Using the text driven route mode screen the system guides the operator through the collection of data step by step machine by machine in a clear text display.

# VIBXPERT Data collector and analyser



To further support and enhance error free data collection VibXpert is compatible with the VIBCODE system which automatically recognises machine measurement location and measurement parameters. VIBCODE fingerprints each measurement location and provides positive stud locations onto which the transducer is mounted. Location, transducer pressure and orientation are always the same irrespective of operator changes or skill.

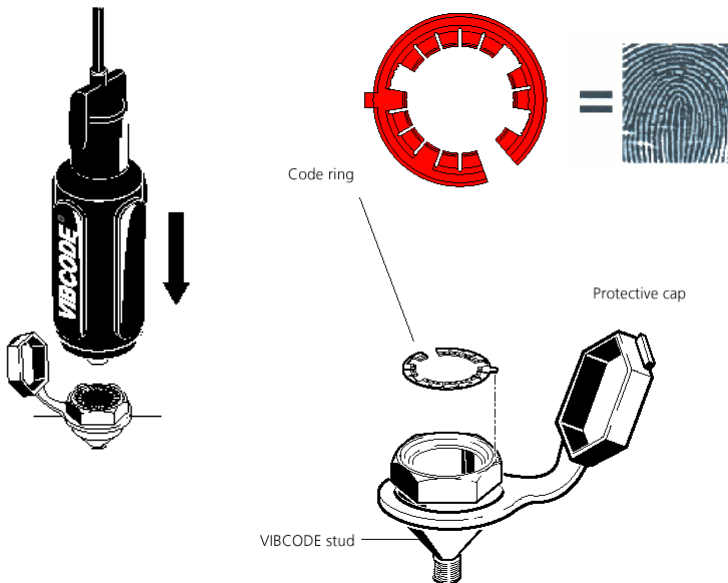

# VIBSCANNER®

## 1 and 2 plane Dynamic balancing

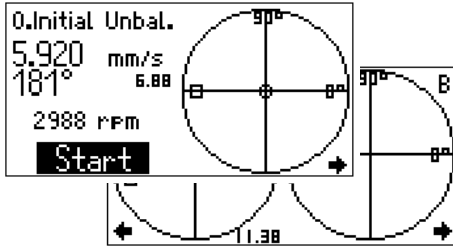

Balance corrections in 1 or 2 planes

Correction
free
fixed location
fixed mass
meas tape

Multiple correction flexibility

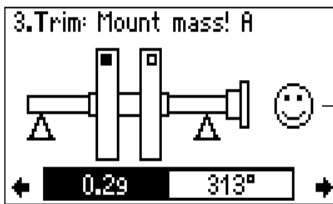

Easy to interpret graphic display



**Intrinsically safe  
option available**

---

# Section 3

# Dynamic

# Balancing

According to ISO standard 1940 - 1973 (E)

“Balancing is the process of attempting to improve the mass distribution of a body so that it rotates in its bearings without unbalanced centrifuge forces”.

Our focus in this handbook is to look at balancing standards for simple rotating machines with rigid rotors, and how by using calculation and portable balancing systems such as the Pruftechnik VIBSCANNER these balancing standards can be achieved.

As with shaft alignment, balancing of rotating machines will contribute significantly to improving machine reliability and hence to improving production profitability.

Unlike with shaft alignment, where if necessary it is possible to align a machine set to a zero, zero alignment condition, it is not possible to balance machines to a zero unbalance state. Even after balancing, machines will continue to have some residual imbalance. Using modern systems it is possible to reduce machine unbalance to very low levels, it is however not economic to pursue very low unbalance levels on most standard machines. To what extent unbalance should be reduced, and where the economic compromise between pursuing lower unbalance levels and accepting what has been achieved, is a subjective issue. ISO standards can however be used as a good guide to acceptable unbalance conditions. Standards use machine operating speed and rotor mass to establish guide levels which can be applied. Balance quality is classified in a range from G 0.4 to G 4000.

For most standard rotating machines such as fans, pumps and motors the range we should be concerned with is from G 6.3 to G1. Depending on individual plant operation and commissioning standards some plants will specify a balancing standard within this range.

The ISO standard does not intend that balance standards are used to

# Balancing Standards

determine acceptance test for specific rotor types, they are more designed as in indication of unbalance acceptability based on experience and historical evaluation of machine operation.

In general the larger the rotor mass the greater the permissible unbalance. Permissible unbalance  $U$  is related to rotor mass  $m$  to give the specific permissible unbalance of the rotor as the formula :

$$e = U/m$$

Balance Grade G in mm/sec	Rotor types
0.4	Gyroscopes, Spindles and armatures of precision grinders
1.0	Small electrical armatures with high balance requirements Tape recorder and gramophone drives, cinema projectors, High precision grinding machine drives
2.5	Rotors of steam and gas turbines, turbo-generators, turbo-blowers and turbine pumps. Medium and large electric armatures with high balance requirements. Small electric armatures with reasonable level of balance requirement Small electric armatures not included in grade 6.3. Fans for air conditioning in quiet environments High speed reduction gears (over 1000 rpm)
6.3	Small mass produced electric armatures in applications with anti vibration assemblies. Medium and large armature assemblies (> 80 mm shafts) without special balance requirements. Machine tool components and machine tools in general Fly wheels, fans, centrifuge pumps, reduction gears in marine applications Cylinders and rolls for printing machines. Gas turbine rotors
16	Drive and cardan shafts with high level balance requirements Components for agricultural, grinding and threshing machines Components for automobile and locomotive applications Crank shafts with fly-wheel and clutch assemblies Normal drive pulley applications Large cylinders for paper manufacture.
40	Wheels and wheel rims for cars, drive shafts and axle assemblies for cars. Crankshaft with fly-wheel and clutch assembly - 4 stroke engines
100	Crankshafts for diesel engines .6 cylinders and piston speed .9mm/sec Complete engines for autos and locomotives
250	Crankshafts for rigidly mounted 4 cylinder diesel engines with piston speed . 9mm/sec
630	Complete crankshafts for large rigidly mounted 4 stroke engines Complete crankshafts for elastically mounted marine diesel engines
1600	Complete crankshafts for large rigidly mounted 2 stroke engines
4000	Complete crankshafts for large rigidly mounted marine diesels with a piston speed < 9mm/sec

*general classification for standard machines ISO1940/1*

## Balancing Standards

---

Practical experience shows that for rotors of the same type the permissible specific unbalance varies as the speed of the rotor changes. This produces a chart of permissible unbalance against rotor speed as shown on the following page.

Using the balance grades as shown in the guide table an estimate of the acceptability of the unbalanced condition of a rotor can be established.

ISO 1940-1973 (E) suggests a variation as follows can be used to when measuring and assessing the balance quality of a rotor compared to the standard table.

Balance quality grades	Permissible deviation
<b>G 2.5 - G16</b>	+/- 15%
<b>G 1</b>	+/- 30%
<b>G 0.4</b>	+/- 50%

The graph on page 135 is a simplified version of the ISO standard graph, in bold are the most commonly used balance grades for standard machine types. For standard motors, pumps, fans etc the most commonly used balance grades are in the range of 2.5 and 6.3 in exceptional cases grade 1.0 can be used, this however is an exacting standard for such applications.

Before embarking on corrective action for unbalance it is essential to eliminate any extraneous causes of vibration such as looseness, rubs or misalignment. Analysis as described in the previous section will help establish the primary source of vibration; this should be attended to first.



# Balancing Standards

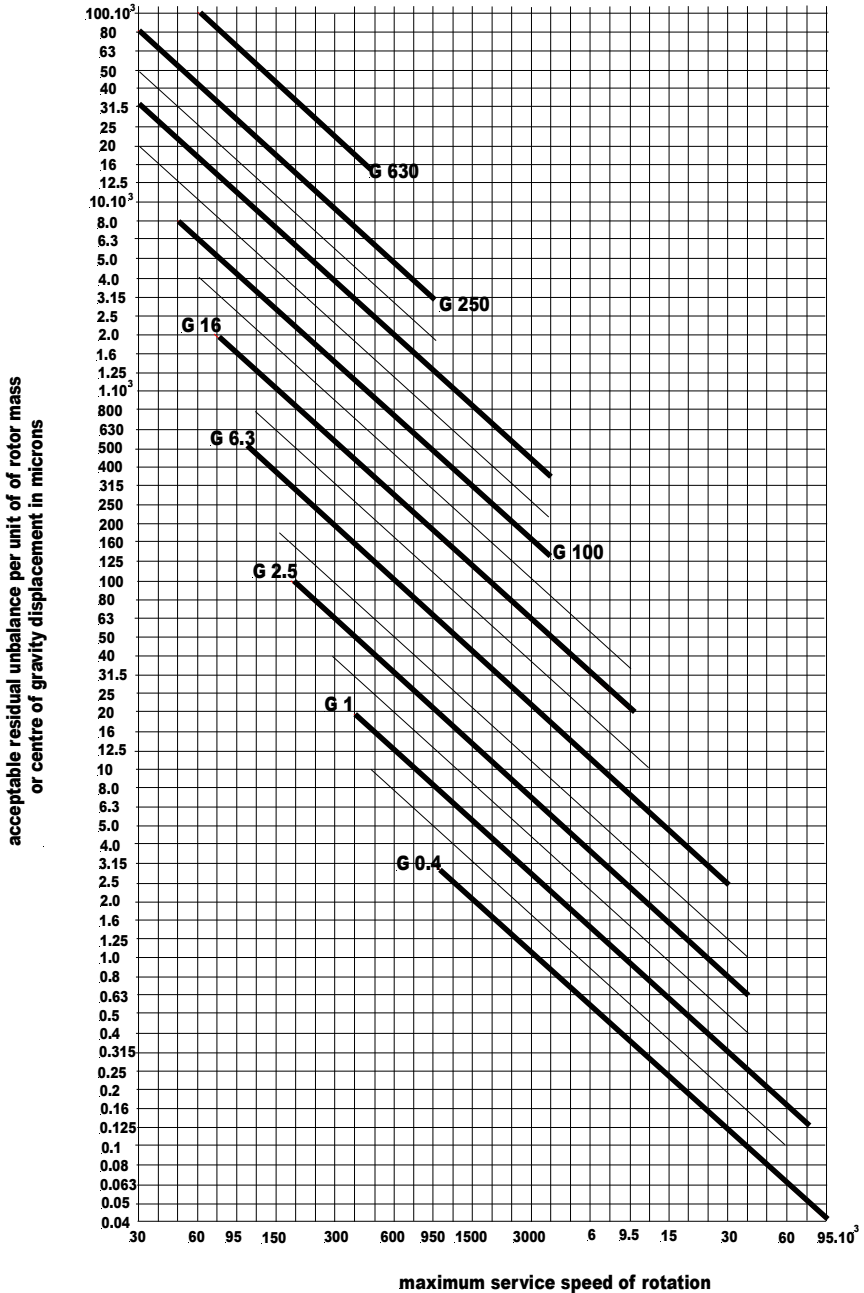

source ISO standard 1940-1973 (E)

## Balancing Correction methods

---

By far the major method of correcting rotor unbalance is by use of a specifically designed balancing machine or portable balancing system such as the Pruftechnik VIBSCANNER. The use of static balancing machines and the types available is not a subject covered in this handbook, here we are focussed on in-situ balancing as addressed by most portable systems. It is useful however to look at a method of determining unbalance in situ without the aid of a dedicated balancing system, this will help to establish basic balancing requirements and will most likely underline the usefulness of investing in a balancing system that eliminates the rather complex calculations that are necessary.

In-plant balancing should be performed under normal operating conditions, and at normal speed.

Should this be precluded by unbalance having become excessive already so that normal operation would be too dangerous, pre-balancing must first be performed at reduced speed to lower vibration severity, followed by final balancing at normal speed. The locations on the rotor at which trial weights and balance weights are fixed in the balancing planes must be freely accessible. Dismantling of major components in between trial runs may alter external influences in such a manner that the measurements of the individual runs are no longer comparable.

An appropriate measuring point – identical with all runs – should be identified at the location where the vibration measurement instrument indicates the highest vibration value.

With all procedures, vibration severity can be measured in the form of  $v_{\text{eff}}$ , displacement amplitude,  $s$ , or acceleration amplitude,  $\hat{a}$ . For the purpose of simplicity, the following discussion is based on  $v_{\text{eff}}$  only, further abbreviated to  $v$ .

Just as with car wheels, balancing is performed in the main by adding balance weights, less frequently by removing weight. Hence it is a matter of determining the location where the balance weight must be added, and how heavy it must be.

## Balancing Correction methods

---

There are several procedures for determining location and amount of the balance weight. But depending on the geometry of the rotor to be balanced there are basically two methods for correcting rotor unbalance which we shall consider here.

**Single-plane balancing** for mechanical assemblies having, essentially, one rotor whose thickness is smaller than its radius, e.g. the majority of fans, belt pulleys or half-couplings.

With this method, the mass centre plane is called **balancing plane**.

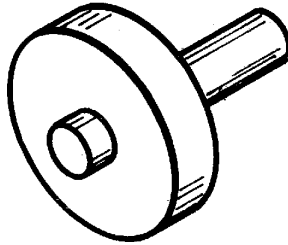

**Two-plane balancing** is designed accordingly for use with machines having two or more rotors, or having one rotor whose width exceeds its radius.

With this method, the two **balancing planes** are the left and the right side, or the front and the rear side, respectively.

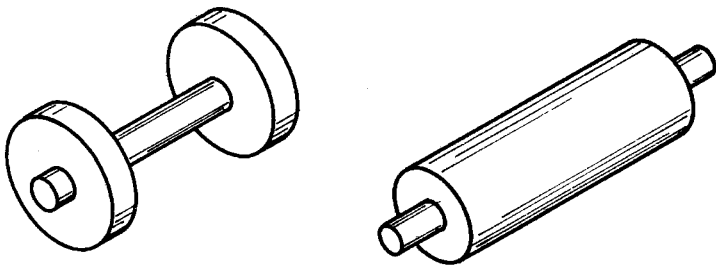

## Single plane balancing

To be able to define the position of the balance weight, the rotor is graduated anticlockwise in degrees, from  $0^\circ$  to  $360^\circ$ . The graduation can be applied to the front face or to the side of the rotor, depending on where the balance weight is to be added later on.

In the event of a cover permitting access to the rotor in one particular place only, a  $0^\circ$  mark is applied first, and from this mark the other angles can be measured by conversion of radius and circumference.

There are several procedures again for both single-plane and two-plane balancing. Set out below are two procedures for single-plane balancing first, for ease of understanding each one is explained on the basis of an example.

### Single-plane three-point balancing

The first procedure is the **single-plane three-point**.

The only accessories required are a trial weight and a pair of compasses.

As can be implied from the name, three test points, T1, T2, T3, for attachment of a trial weight are marked out on the rotor, at  $0^\circ$ ,  $120^\circ$  and  $240^\circ$ .

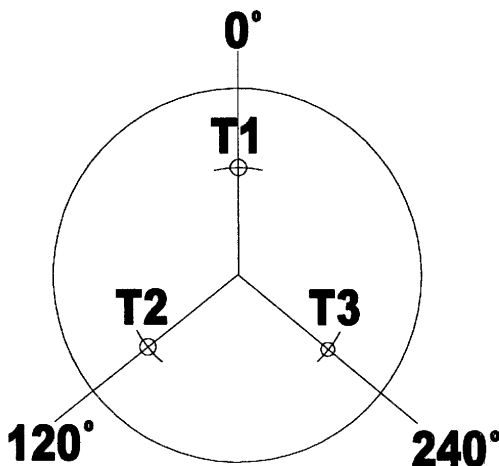

## Single plane balancing

---

A convenient size of the trial weight can be determined by means of the formula;

$$MT = \frac{G \times s}{r}$$

Where MT is the trial weight, G the weight of the vibrating parts, s the displacement amplitude of vibration, and r the distance between the trial weight and the rotational axis.

It is of course sufficient for the trial weight to be only approximately this size, even 1.5 times or half the calculated weight is permissible.

As a first step, a trial run is made without a trial weight, to record the vibration severity VO. Assume the result is

$$VO = 8.0 \text{ mm/s.}$$

Care must be taken to ensure that VO is measured at the rotational frequency.

Then the trial weight MT is fixed to the points T1, T2, T3 by turns, and each time a trial run of the machine and a measurement of vibration severity, v, is performed. Assume the measuring results are

$$V1 = 6.4 \text{ mm/s}$$

$$V2 = 13.0 \text{ mm/s}$$

$$V3 = 7.6 \text{ mm/s}$$

The trial weight in this example is  $MT = 22.5 \text{ g}$ .

The measurement can best be evaluated on an prepared sheet showing a basic outline graduated in degrees as shown on the following page.

# Single plane balancing

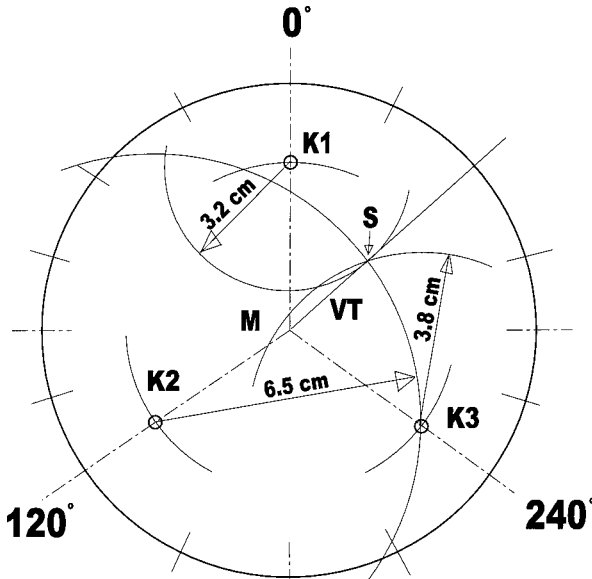

Values	Results	
without trial weight VO = 8.0	VT = 5.0	WA = 307 deg
Trial weight at 0 deg V1 = 6.4		MA = 36 g
Trial weight at 120 deg V1 = 6.4		
Trial weight at 240 deg V1 = 6.4		
Trial weight MT = 22.5		

A suitable scale is selected for the purpose, e.g. 1 cm corresponds to 2 mm/s, and a circle is drawn with M as its centre and VO as its radius; in our example, this would mean:  $r = 4.0$  cm. The points of intersection of this circle with the three legs 1, 2 and 3 are the points K1, K2 and K3.

The next step is to draw circles around these points: with a radius of V1 (i.e. 3.2cm) around K1; with a radius of V2 (i.e. 6.5 cm) around K2; and with a radius of V3 (i.e. 3.8 cm) around K3. It does not matter if these circles do not fit on the paper in their entirety. The crucial point is the common intersection of all three circles, the point S.

# Single plane balancing

---

The angle WS represented by the leg M to S gives the angle at which the balance weight MA must be fixed to the rotor; in this case,

$$WA = 307^\circ.$$

The length of the segment M to S is measured and denoted by VT; in the example above.

$$VT = 5.0 \text{ mm/s.}$$

As a general rule, the balance weight is fitted at the same distance r from the centre as the trial weight, in which case the balance weight MA is calculated according to the formula

$$MA = V0 \cdot MT / VT = 8 \times 22.5 / 5$$

The result obtained in our example is

Correction weight MA = 36 g. located at 307 degrees from 0

If the balance weight is to be fixed at a shorter or greater distance R than from the axis, the balance weight must be calculated as follows:

$$MA(1) = r / R \times MA$$

In most cases the measurements will not intersect at one point as shown in our example, intersection S has been somewhat idealised. Most instances will resolve a small triangle (detail a) or in exceptional circumstances there may not even result a complete triangle (detail b). In these cases a mean value should be selected from the hatched portion of the intersect area.

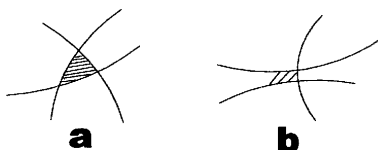

# Single plane balancing

Should the triangle or the hatched area for once be very large, vibration is not attributable to unbalance but to other defects (provided measurement and evaluation have been performed correctly). In that case, another vibration analysis must be carried out, preferably backed by shock pulse measurement.

## Single-plane stroboscope method

The second procedure considered here for single-plane balancing is the **single-plane stroboscope method**. The additional instrument required is a stroboscope which can be synchronised with the machines rotational frequency via a vibration analyser. This method is more expensive than the previous method. But it has the advantage that just two trial runs are required instead of four, and that evaluation can be made both graphically and by calculation.

For balancing, the rotor is again graduated anticlockwise in degrees, from  $0^\circ$  to  $360^\circ$ . During measuring, this graduation is viewed by the light of the synchronised stroboscope so that the machine appears to be stationary.

The first run is made without a trial weight. The parameters to be recorded are the vibration severity VO and – with the aid of the stroboscope – the angle WO of the occurring vibration SO. Care must be taken to ensure that VO is measured selectively for the rotational frequency.

For measurement of angles, a reference mark is fixed, e.g. at the top, which is then used for both trial runs and where the angle is read off.

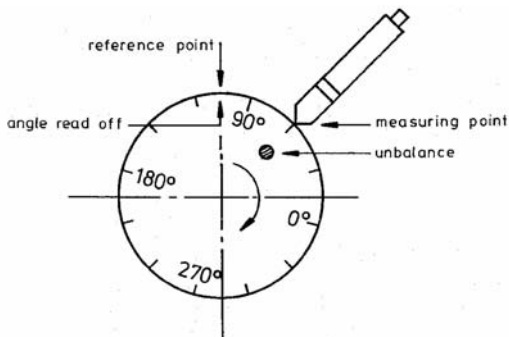



# Single plane balancing

In the second trial run, a trial weight MT is attached at  $0^\circ$ , at a distance  $r$  from the rotational axis; then the vibration ST is recorded, with its vibration severity VT and its phase angle WT, just as in the first trial run. Both the measuring point for the vibration pick-up and the reference mark for measurement of angles must remain unchanged in the process.

The following recorded values are assumed as an example:

$$\text{SO: } VO = 9 \text{ mm/s; } WO = 110^\circ$$

$$\text{ST: } VT = 15.6 \text{ mm/s; } WT = 40^\circ$$

$$\text{Trial weight MT} = 20 \text{ g}$$

## Correction by graphical method

The first step is to plot SO and ST to a suitable scale in a circle graduated in degrees, the final points being O and T. The arrow from T to O is then shifted parallel to the center, its length is measured and is denoted by N, its angle is WN.

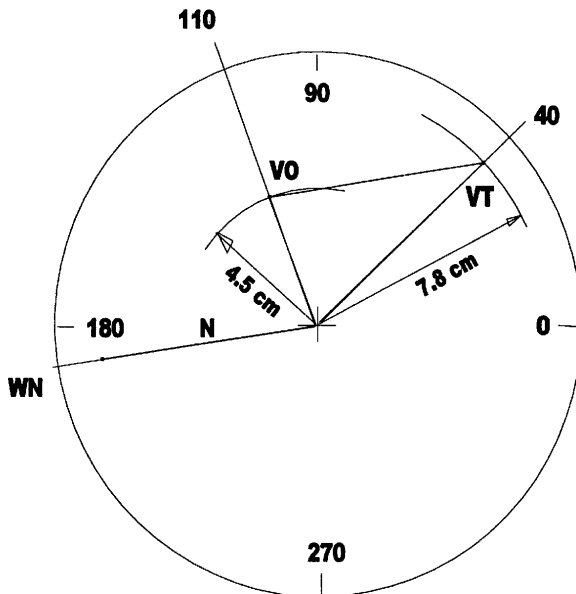

# Single plane balancing

---

The amount of balance weight MA is calculated as follows:

$$MA = SO \cdot MT / N$$

Its angular location is  $WA = WO - WN$

The result is  $WA = 280^\circ, MA = 12 \text{ g}$ .

## Correction by Calculation

For an evaluation by calculation, complex numbers must be used. Unbalance and vibration may be considered complex numbers in polar co-ordinates, and equally the balance weight.

Conversion of these complex numbers into Cartesian co-ordinates will yield the expressions below.

The given quantities are: VO, WO, VT, WT, MT.

$$\begin{aligned} VO &= 9 \text{ mm/s}; & WO &= 110^\circ; \\ VT &= 15.6 \text{ mm/s}; & WT &= 40^\circ; \\ MT &= 20 \text{ g} \end{aligned}$$

stage 1: (conversion of SO and ST into Cartesian co-ordinates,

$$\begin{aligned} SOX &= VO \cdot \cos(WO) & SOX &= 9 \text{ mm/s} \cdot \cos(110^\circ) = -3.08 \text{ mm/s} \\ SOY &= VO \cdot \sin(WO) & SOY &= 9 \text{ mm/s} \cdot \sin(110^\circ) = 8.46 \text{ mm/s} \\ STX &= VT \cdot \cos(WT) & STX &= 15.6 \text{ mm/s} \cdot \cos(40^\circ) = 11.95 \text{ mm/s} \\ STY &= VT \cdot \sin(WT) & STY &= 15.6 \text{ mm/s} \cdot \sin(40^\circ) = 10.03 \text{ mm/s} \end{aligned}$$

stage 2: (calculation of SO – ST)

$$NX = SOX - STX \quad NX = -15.03 \text{ mm/s}$$

## Single plane balancing

$$\begin{aligned}
 NY &= SOY - STY & NY &= -1.57 \text{ mm/s} \\
 N^2 &= (NX)^2 + (NY)^2 & N^2 &= 228.4 \text{ mm}^2
 \end{aligned}$$

stage 3: (calculation of the balance weight)

$$\begin{aligned}
 AX &= (SOX \cdot NX + SOY \cdot NY) \cdot (MT/N^2) & AX &= 2.89 \text{ g} \\
 AY &= (SOY \cdot NX - SOX \cdot NY) \cdot (MT/N^2) & AY &= -11.56 \text{ g}
 \end{aligned}$$

stage 4: (conversion of the balance weight into polar co-ordinates)

$$\begin{aligned}
 MA &= \sqrt{(AX)^2 + (AY)^2} & MA &= 11.9 \text{ g} \\
 WA &= \arctan(AY/AX) & WA &= -76^\circ
 \end{aligned}$$

With respect to WA, allowance must be made for the fact that a calculator will indicate the principle value of arctan, and also that when

$AX = 0$ ; WA is not defined at all. It is therefore advisable either to perform an extra graphical evaluation (doubling as a further check) to definitely identify the angular location; or to plot the balance weight in Cartesian co-ordinates. The exact value of WA is then obtained by adding or subtracting appropriate multiples of  $180^\circ$ .

This is the case in our example where the result of both the graphical evaluation and the plotting of the Cartesian co-ordinates is about  $285^\circ$ ;  $360^\circ$  must thus be added to the previously calculated value to obtain the exact value of  $WA = 284^\circ$ .

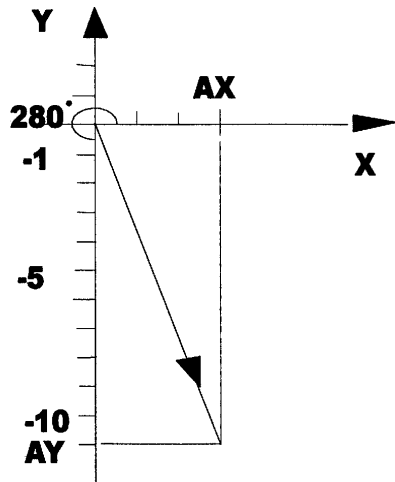

## Single plane balancing

---

Just as with the single-plane three-point method, the calculated balance weight  $MA$  must be attached at the same distance,  $r$ , from the centre as the trial weight. In case another spacing is preferred, the balance weight must be converted according to the principle of the lever again.

With the single-plane stroboscope method, calculation is as follows:

If  $U$  is the unbalance, the first measurement yields

$$(i) \quad SO = a \cdot U$$

with a complex parameter  $a$ .

In the second measurement, the trial weight  $T$  is added to the unbalance  $U$  so that the result of the measurement is

$$(ii) \quad ST = a \cdot (U+T)$$

From (i) there results  $a = SO/U$ , and inserting this into (ii) yields

$$ST = SO \cdot (U+T)/U$$

Resolving to  $U$  yields

$$U = (SO \cdot T)/(ST-SO)$$

The balance weight  $A$  must be opposite to  $U$ :

$$A = (SO \cdot T)/(SO-ST)$$

## Two plane balancing

---

### Two-plane stroboscope method (devised by A Wahrheit)

If the rotor assembly concerned has either two rotors or one rotor whose width exceeds its diameter, two-plane balancing methods must be used. We will review one two plane balancing method and will show calculations to obtain balance correction weights and location. The two ends of the rotor represent the two balancing planes E1 and E2.

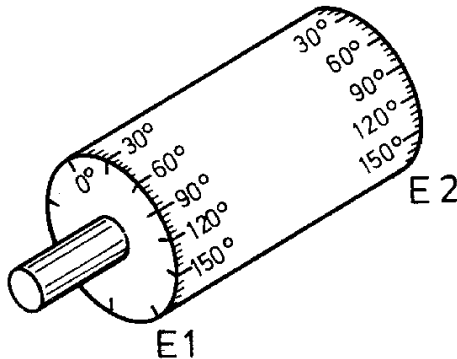

This method is similar to the single-plane stroboscope method, especially in that identical equipment is required, i.e. a frequency-selective vibration measuring instrument and a stroboscope.

A graduation in degrees is again applied to both balancing planes, the position being identical with both planes.

A total of three trial runs must be made, the first one without a trial weight and the other two with a trial weight added. The trial weight is always attached at 0°, first in the balancing plane E1 and then in the balancing plane E2

With all three trial runs, either balancing plane is measured in respect of vibration severity and, with the aid of the stroboscope, phase angle.

12 recorded values are thus obtained, and the 13<sup>th</sup> value is the trial weight:

## Two plane balancing

---

Without trial weight:

$$E1: V10 = 14.7 \text{ mm/s}$$

$$W10 = 56^\circ$$

$$E2: V20 = 12.0 \text{ mm/s}$$

$$W20 = 75^\circ$$

With trial weight at E1:

$$E1: V11 = 27.3 \text{ mm/s}$$

$$W11 = 33^\circ$$

$$E2: V21 = 14.1 \text{ mm/s}$$

$$W21 = 55^\circ$$

With trial weight at E2:

$$E1: V12 = 18.5 \text{ mm/s}$$

$$W12 = 45^\circ$$

$$E2: V22 = 23.9 \text{ mm/s}$$

$$W22 = 44^\circ$$

Trial weight:  $MT = 60 \text{ g}$

On the basis of the 13 values recorded, a calculation is then made to determine the angles in both balancing planes at which the balance weights are to be fixed, and also the value of those weights. Four values are thus obtained: MA1; WA1 and MA2; WA2. The calculating procedure is as follows. Refer to the chart on page 123.

**Step I**, The measuring results are entered in the top portion of the evaluation sheet.

**Step II**, Columns I and II are completed as specified. The highest result of operation I is underlined, the other results of I are then divided by this value, multiplied by 10 and entered in column VX on the right. The angles resulting from operation II are moved directly to the column WX; should an angle exceed  $360^\circ$ , however,  $360^\circ$  must be subtracted until the result is in the range from  $0^\circ$  to  $360^\circ$ .

The points A to F are plotted with amount and angle into the circle. (The radius of the circle corresponds to 10.)

The amounts and angles of K (centre of AB), L (centre of CD) and S (centre of gravity of the triangle KLM, M centre of E F) are read off and entered in the respective spaces.

## Two plane balancing

---

**Step III**, Determines two auxiliary quantities,  $Z_1$  and  $Z_2$ , which are eventually used to calculate the sizes and angular locations of the balance weights.

The principals of the two-plane stroboscope method are as follows:

As with the single-plane stroboscope method, the unbalances in the balancing planes E1 ( $U_1$ ) and E2 ( $U_2$ ) as well as the trial unbalance,  $T$ , are defined as complex numbers.

For the vibration severity levels without trial weight there follows:

$$\begin{aligned} S_{10} &= a \cdot U_1 + b \cdot U_2 & S_{10} &= (V_{10}; W_{10}) \\ S_{20} &= c \cdot U_1 + d \cdot U_2 & S_{20} &= (V_{20}; W_{20}) \end{aligned}$$

Where  $a$ ,  $b$ ,  $c$  and  $d$  are complex parameters,  $b$  and  $c$  represents the effects of the unbalances on the other balancing plane.

Since the equations contain six unknown quantities ( $a$ ,  $b$ ,  $c$ ,  $d$ ,  $U_1$ ,  $U_2$ ), four more equations are needed; they are obtained from the two trial runs with trial weight.

$$\begin{aligned} S_{11} &= a \cdot (U_1 + T) + b \cdot U_2 & S_{11} &= (V_{11}; W_{11}) \\ S_{21} &= c \cdot (U_1 + T) + d \cdot U_2 & S_{21} &= (V_{21}; W_{21}) \end{aligned}$$

$$\begin{aligned} S_{12} &= a \cdot U_1 + b \cdot (U_2 + T) & S_{12} &= (V_{G12}; W_{12}) \\ S_{22} &= c \cdot U_1 + d \cdot (U_2 + T) & S_{22} &= (V_{22}; W_{22}) \end{aligned}$$

There results the following solutions:

$$U_1 = \frac{(S_{10} \times S_{22}) - (S_{20} \times S_{12})}{S_{20}(S_{12} - S_{11}) + S_{21}(S_{10} - S_{12}) + S_{22}(S_{11} - S_{10})} \times T$$

$$U_2 = \frac{(S_{11} \times S_{22}) - (S_{10} \times S_{21})}{S_{20}(S_{12} - S_{11}) + S_{21}(S_{10} - S_{12}) + S_{22}(S_{11} - S_{10})} \times T$$

With regard to the balance weights  $M_1 = -U_1$  and  $M_2 = -U_2$ .

# Two plane balancing

Balancing

Two-plane stroboscope method

Machinery:

Date:

Values:	Plane E1 amount angle	Plane E2 amount angle	Trial weight:
1. without trial weight:	V10=14. W10=54	V20=12.0 W20=75	MT= 60g
2. trial weight at E1:	V11=27.3 W11=33	V21=14.1 W21=55	WT= 0°
3. trial weight at E2:	V12=18.5 W12=45	V22=22.2 W22=94	

I	II		VX	WX
V12 · V20 222	W12 45 +W20 75 120	A	3.4	120
V10 · V22 351	180° +W10 56 +W22 44 280	B	5.38	280
V10 · V21 207	W10 56 +W21 55 111	C	3.18	111
V11 · V20 328	180° +W11 33 +W20 75 288	D	5.02	288
V11 · V22 (652)	W11 33 +W22 44 77	E	10	77
V12 · V21 261	180° +W12 45 +W21 55 280	F	4.00	280

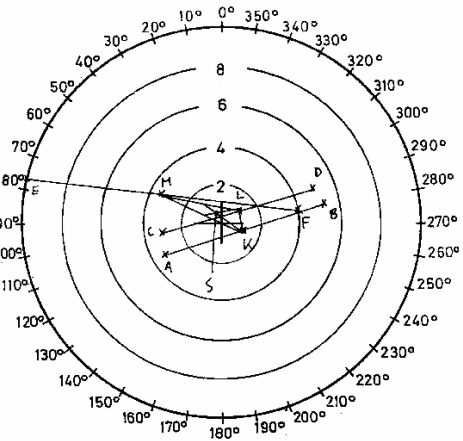

VK = 1.33	VL = 1.11	VS = 0.67
WK = 250	WL = 290	WS = 20

III	$\frac{1}{3} \frac{MT}{VS} = 29.85$ (Z1)	360° - WS = 340° (Z2)
-----	--	-----------------------

Balance at E1		Balance at E2	
MA1 = Z1 · VK	WA1 = Z2 + WK	MA2 = Z1 · VL	WA2 = Z2 + WL
MA1 = 39.7	WA1 = 230°	MA2 = 33.13	WA2 = 270°

Sign:



## **Two plane balancing**

---

It is obvious from the proceeding pages that calculating unbalance corrections even on simple rotors in both one and two planes involves a complex series of graphical or mathematical (or both) calculations. additionally the balancing methods reviewed are based on the assumption of ideal linear conditions, which is rarely encountered in reality. Corrections may therefore require a second and in extreme cases a third balancing procedure to achieve the balance quality required.

There is however a more straightforward method of in situ dynamic balancing which substantially reduces the time required to achieve an acceptable balance quality and all but eliminates the complex calculations of the previous methods.

Dedicated balancing systems such as the VIBSCANNER shown in the following pages will perform balancing in one or two planes, will graphically describe balance weight corrections and locations or will allow the operator to select suitable mounting locations (on the blades of a fan for example) and will automatically compensate weight requirements to accomodate this.

The time saved and the improved accuracy from such systems makes the initial investment well worthwhile

## **Trial Weight calculation**

---

Most suitable trial weights are small screw cramps that are easy to install and to remove at any location desired. But screws or bolts can be used as well, provided the respective locations are fitted with the tapped holes required. Additionally, an exactly weighed quantity of a special putty can also serve as a trial weight.

It goes without saying that the trial weights must be weighed, and secured to the rotor carefully. If balancing work needs to be done fairly frequently, a set of trial weights could be prepared and kept in readiness.

Instruments such as the VIBSCANNER described in the following pages will calculate the trial weight to be used and will identify the location, if however the unbalance is to be calculated or resolved graphically it is necessary to accurately calculate the amount of trial weight to be used as follows.

A convenient size of the trial weight can be determined by means of the formula below, where MT is the trial weight, G the weight of the rotor, s the displacement amplitude of the vibration, and r the distance of the trial weight from the centre.

$$MT = \frac{G \times s}{r}$$

If a bolt is to be fitted as a balance weight, the respective tapped hole must be deducted from the weight of the bolt.

## Balancing Safety

---

When performing in situ balancing on rotating machines it is essential that operators are aware of the in plant and local HSE safety requirements for working on the machines, and additionally are mindful of the implications and safety requirements when mounting balance weights to machines. Guide lines supplied below should be the minimum precautions taken.

- Isolate machines to avoid accidental switching on when work is being carried out.
- When assembling measurement components ensure that no fixtures, cables etc project within the vicinity of rotating machine parts.
- Follow manufacturers directions when attaching balance weights.
- Always operate within the maximum permissible RPM of the rotor.
- Always pay particular attention to the calculation of the trial mass to be used for the initial balance run. Oversize trial masses can have grave consequences for machines and operator alike.
- During trial and balancing runs ensure no operators are within the radial vicinity of the machine.
- Close all access guards and doors to the rotor before switching on the machine.
- Do not exceed the permitted number of machine start ups for any given time.
- Before balancing begins determine the cause of unbalance and where possible remove any material which may be caked on to the rotor, weld any cracks in impellor blades or replace the impellor if this is not possible.

# VIBSCANNER Balancing system

The principle of operation of the VIBSCANNER system is similar to that of revolving balance by graphical or calculation method. Each method requires the following:

- A preliminary machine measurement to establish current unbalance condition.
- Either one or two trial measurements with trial weights (depending on number of planes to balance, one plane requires one trial run).
- A trim run to correct rotor unbalance. (it may in some cases be necessary to carry out two trim runs to achieve final balance condition)



The fundamental difference between VIBSCANNER and manual balance methods is that the instrument carries out all necessary calculations and reports corrective action to be taken.

Different machine type configurations can be initially selected to establish either single or two plane balancing requirements.

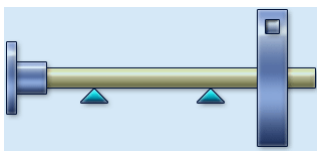

Rotor overhung

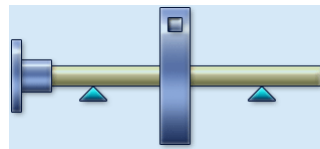

Rotor intermediate

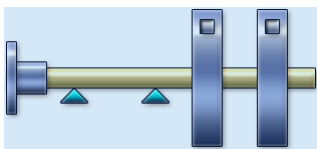

Rotor 2 plane overhung

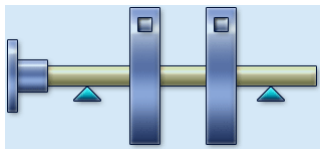

Rotor 2 plane intermediate

# VIBSCANNER Balancing system

A simple balance procedure is as follows.

Take an initial machine vibration measurement. When measured values have stabilised stop the measurement, the reading is displayed thus:

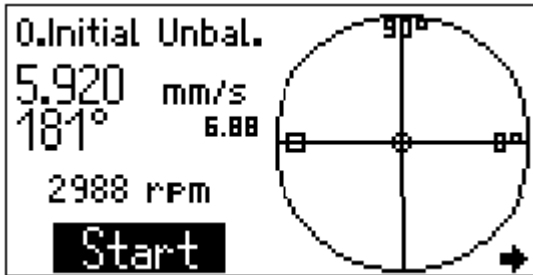

Move to the next input screen to initiate a trial run :

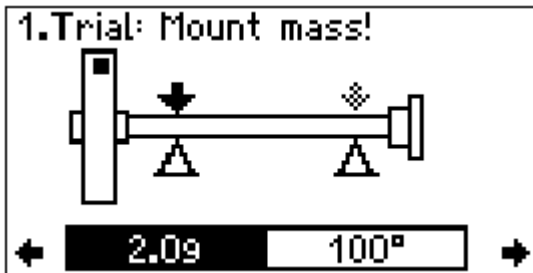

Attach a trial mass as indicated. Run the machine with this new mass. Stop the machine when measurements have stabilized. The unbalance condition with the trial mass is displayed thus:

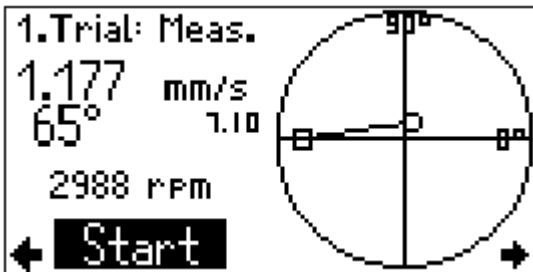

# VIBSCANNER Balancing system

If the unbalance condition has changed from the initial measurement continue onto the trim run. At this point the operator can either remove the trial mass or leave it in place. (the system auto calculates any necessary adjustments that have to be made).

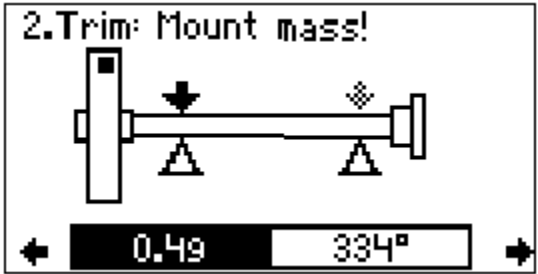

Attach the proposed trim mass at the specified angle and run the machine. The unbalance condition of the machine is displayed thus;

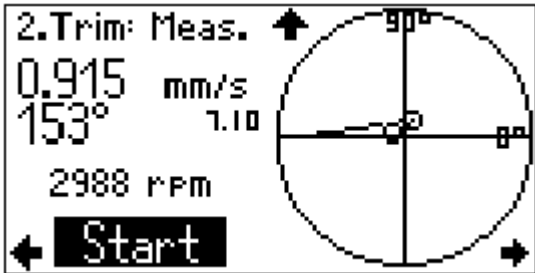

The balancing is complete as soon as the balance quality has been reached, this is indicated by the 'smiley'.

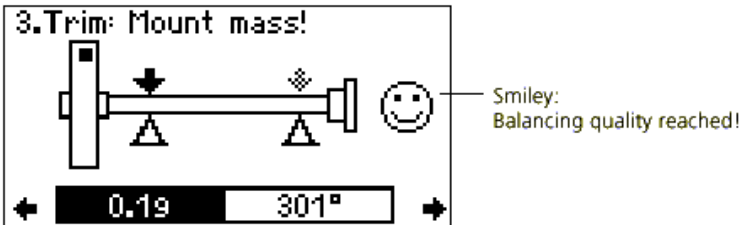

## VIBSCANNER Balancing system

Balance quality is initially set up when the machine type is selected prompting the input of the balance grade required according to ISO 1940 - see page 121 of this handbook.

The system also displays all measurement steps that have been taken including initial, intermediate and final machine vibration figures as shown below.

Data window		No	Mass An9 [g] [°]	Uib An9. [mm/s] °
Initial unbalance		0		5.92 181
Trial run		1		1.18 65
1st trim run		2	0.4 334 ✓	0.92 153
2nd trim run		3	1.5 330 *	2.37 311
...				

Trial/ trim mass
Meas. value
Phase angle

Mounting angle
Mass left on rotor: ✓
Mass removed from rotor: \*

Two plane balancing follows the same easy steps the only difference being that two trial runs are required with a mass on each balancing plane.

In addition to this standard option which assumes free access to all locations on the balancing plane the system offers options to fix locations for the balance mass (on the blades of a fan for example). VIBSCANNER then calculates two masses to correct the measured unbalance at designated fixed locations.

Additionally tape measure locations for masses can be specified instead of angular locations, to enable easy positioning of masses when angular measurements are not possible.

## About Pruftechnik

---

Pruftechnik is an international company involved in the design, manufacture and sale of measurement and diagnostic systems used for laser alignment, condition monitoring, and nondestructive testing.

Originally founded in 1972 in Munich by Dieter Busch, the company first acted as a marketing company for a range of metal detector systems and bearing testing equipment.

As the company became established a new range of its own designed Eddycurrent testing systems was developed, followed over the next few years by the worlds first laser shaft alignment system OPTALIGN again followed later by vibration analysis and dynamic balancing systems. All designed with the unique Pruftechnik approach to simplicity of operation and application.

Pruftechnik head office is still located in Germany but we have established sister companies in the UK, Belgium, Netherlands, France, Singapore, Italy, Spain, Canada, Russia and Poland. In addition to this we have a network of more than 60 sales partners throughout the world.

For Pruftechnik being close to our customers is the essential ingredient to our past and future success. Many of our current products are the result of long established working relationships with our customers, being close to the market is more than a slogan. To us it's a commitment!

In addition to our unrivaled range of products Pruftechnik have an international training, service and support organisation that provides product training, consultation services, and specialised services in areas such as turbine alignment, installation, commissioning and planning of condition monitoring systems.

Pruftechnik hold more than 200 world wide patents together with 100 registered trademarks for its innovative range of products.



### Milestones in Pruftechnik Product development history

- 1976 First eddy current testing device with a modular design for the nondestructive inspection of semi-finished products.
- 1977 First eddy current testing device with microprocessor-based signal processing.
- 1980 **EDDYTHERM®** First microprocessor-driven induction heater for mounting bearings.
- 1981 First alignment computer for shaft alignment with an LCD graphic display.
- 1982 First high-performance induction heater for large bearings.
- 1983 **OPTALIGN®** First laser-optical shaft alignment system.
- 1985 First eddy current rotating system with a coaxial construction
- 1987 **PERMALIGN®** First laser-optical coordinate measuring system for four degrees of freedom.
- 1988 **EDDYCHEK 3** First computer-driven eddy current testing device with multi-frequency/multi-channel capabilities for defect testing of semi-finished products.
- 1989 **SYSTEM 2®** First multifunctional measuring device with a softkey user interface, insertable program and memory cards, and insertable hardware modules to allow configuration of the hardware as required.
- 1990 First optical 5-axial sensor that evaluates a laser beam simultaneously in five degrees of freedom and transmits the results to a computer via a wireless IR system.
- 1991 First 'tandem piezo accelerometer' for vibration and shock pulse measurement.
- 1992 First diagnosis and measuring system for rotating machines; capable of alignment assessment, vibration analysis (FFT), balancing and machine diagnosis.
- 1992 **XTECTOR®** First 'intelligent sensor' for vibration, bearing and cavitation measurement.
- 1992 **CENTRALIGN®** First commercially-available measuring system for determining turbine housing alignment by laser-optical methods.
- 1993 **VIBROTIP®** First multifunctional measuring device with five

- different measurement functions (vibration, cavitation, shock pulse, temperature and speed); contains memory and software for trending and archiving measuring data.
- 1993 First industrial vibration receiver with a line drive amplifier for use in severe environments; with socket-free cable connection.
- 1994 **EDDYCHECK**<sup>®</sup> 4 Multi-channel realtime eddy current testing device with touchscreen operation.
- 1994 **ROTALIGN**<sup>®</sup> - First shaft alignment system suitable for industry (water-tight, shock-proof and drop-proof), with patented Sweep method for taking measurements.
- 1995 **VIBCODE**<sup>®</sup> ‘changes the world of data collectors’ – and automatically correlates measured values with measuring locations.
- 1995 Eddy current testing system for hot rod inspection.
- 1996 **VIBRONET**<sup>®</sup> – First system for continuous vibration and impulse monitoring with an easy-to-install multiplex design using current line drive technology.
- 1997 **OPTALIGN**<sup>®</sup> **PLUS** – Laser-optical alignment system suitable for industrial applications and featuring very user-friendly operation.
- 1998 First telediagnostic system with Internet capabilities for remote diagnosis and analysis of bearing and gears; based on **VIBRONET**<sup>®</sup> and the Intermac system of Schühle GmbH.
- 1999 **VIBROCORD**<sup>®</sup> - New FFT data collector, suitable for industrial applications and designed for user-friendly operation.
- 2000 **VIBSCANNER**<sup>®</sup> - First data collector with joystick and multifunctional menus.
- 2000 **EDDYCHECK**<sup>®</sup> **5** – Two-channel digital eddy current testing equipment with networking capabilities and a touchscreen display.
- 2002 **smartALIGN**<sup>®</sup> - the first shaft alignment system with joystick control.

- 2003 **PARALIGN**<sup>®</sup> - the worlds first inertial laser alignment system using laser gyroscopes to resolve parallel measurement of rollers.
- 2003 **NOVALIGN**<sup>®</sup> - multi-function laser alignment system with large colour screen display and bluetooth PC & printer interface.
- 2004 **VIBROWEB**<sup>®</sup> web serviced on line system for insitue measurement of vibration condition on wind turbines.
- 2004 **LEVALIGN**<sup>®</sup> rotating laser system for measurement of flatness
- 2004 **VIBXPERT**<sup>®</sup> 2 channel FFT analyser and data collector with 102,000 line of resolution.
- 2004 **ROTALIGN**<sup>®</sup> **ULTRA** - new laser shaft alignment system with high resolution colour screen and Bluetooth sensor, PC and printer connectivity.
- 2006 **Optalign**<sup>®</sup> **Smart** Laser Shaft alignment system with Bluetooth sensor communication, enhanced colour screen and graphics, and customer selectable modular operating functions.
- 2007 **CSD Check** Laser system for the measurement of Crank Shaft Deflection
- 2007 **Vibnode**<sup>®</sup> 6 and 12 channel on line system for frequency selective monitoring of standard machine sets.
- 2007 **Hydralign**<sup>®</sup> Online system for long term monitoring of plant and machine foundations.
- 2008 **Optalign**<sup>®</sup> **Smart** ATEX approved intrinsically safe laser alignment system.
- 2008 **VIBXPERT**<sup>®</sup> ATEX approved intrinsically safe 2 channel FFT analyser.
- 2008 **INCLINEO**<sup>®</sup> high precision instrument for measurement of angular deviation on flat or vertical surfaces and shafts.
- 2009 **ShaftAlign**<sup>®</sup> dedicated shaft alignment system with colour screen and modular operating functionality.
- 2009 **WEARSCANNER** – Online particle size distribution counter monitors wear debris in oil.

# Glossary of Pruftechnik products

## Laser Alignment systems



**ROTALIGN® Ultra** is the first laser shaft alignment system to feature a backlit Colour screen. The system which is water, shock- and dust proof is a brand new platform for PRÜFTECHNIK's laser alignment systems. The computer, based on the high performance Intel XScale processor provides fast data processing with comprehensive and straightforward features that makes laser alignment of even the most complex systems simple to perform.



**OPTALIGN® Smart** uses Bluetooth cable free sensor communication combined with a high contrast colour scree. It provides a modular approach allowing the user to select the specific alignment functions they require for their plant. In this way the OPTALIGN Smart *Series* can be tailored by price or specification to match exactly the plant maintainers requirements. *The system is available ATEX intrinsically safe to EEx ib IIc T4.*



### **ShaftAlign® New in 2010**

Is a dedicated modular shaft alignment system, offering the usere the facility to tailor the system to the specific measurement requirements of the plant. Featuring a brand new simple user interface and high resolution colour screen Smartalignbrings high spec shaft alignment at a low price.

The system is complete with mounting brackets, computer, laser and rugged carry case.

# Glossary of Pruftechnik products



**PERMABLOC®** Shims are supplied in 4 different machine foot sizes and 8 thicknesses to provide just the right alignment correction for almost any machine. They are manufactured from high quality stainless steel to prevent corrosion when exposed to acids and alkalis and are permanently marked with metric and imperial dimensions for easy selection and fitting. Shims are available in packs of 20 pieces or in shim kits complete with a rugged steel carry case.



**LAMIBLOC®** Shims are available in stainless steel or as a Mylar plastic material. Available in 8 foot sizes, they are exactly 1 mm thick with 12 laminations which allow peeling down to meet any shim correction requirement. Shims are available in packs of 10 and in complete shim kits and as 1 meter x 0.5 meter shim sheets for custom foot sizes.

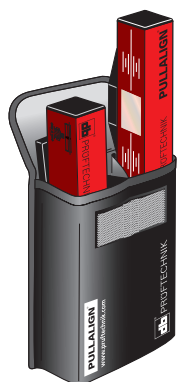

**PULLALIGN®** uses the proven OPTALIGN reflected beam principal to resolve angular and offset pulley misalignment in three simple steps. Powerful magnets attach the laser and reflector to the pulley faces. Graduated lines on the component faces give visual information on current alignment condition and provide clear indications of when the alignment condition has been corrected.

## Glossary of Pruftechnik products

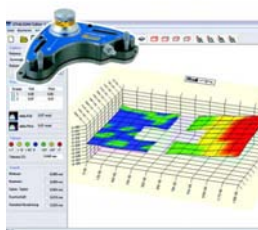

**LEVALIGN®** is an add on or stand alone laser level measurement system based on the ROTALIGN Pro platform. It provides a cost effective solution to precision measurement of simple and complex systems such as; machine foundations, bed plates, tables, flanges, turbine half casings and crane slewing rings. The PC software supplied with the system gives the user the ability to view the measurements in a variety of ways including colour enhanced 3D graphic views.

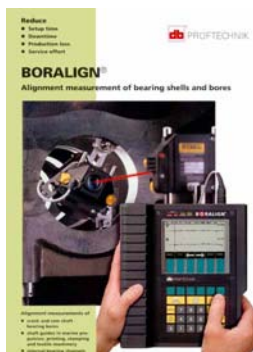

**BORALIGN®** is based upon the Rotalign Pro system, the system can measure bearing pocket bore concentricity, straightness, turbine diaphragm alignment and even flatness of machine surfaces and tables. The system can be supplied either as a stand alone system or as an add on package to the Shaft alignment version of Rotalign Pro. *The system is available ATEX intrinsically safe to EEx ib IIc T4.*



### **INCLINEO® new in 2010**

This versatile system is ideal for any application that requires high precision measurement of flatness, parallelism and inclination. The system has already been successfully applied in determining the geometries of machine tools, levelling of machine beds and plumbing of water turbines. The INCLINEO masters a wide variety of different measurement tasks that simplify and optimize wind tower construction.

## Glossary of Pruftechnik products



**PERMALIGN®** is the worlds only system specifically for in-situe laser alignment measurement of rotating machine position displacement. The system can withstand prolonged operation in high temperatures and via a PC link provides long term data on the operating position change of rotating machines caused by thermal growth or other related phenomina. *The system is available intrinsically safe to EEx ib IIc T4.*



**PARALIGN®** is a new roller alignment system which uses inertial measurement technology in the form of three laser gyroscopes. It provides reliable graphical and numerical information on the parallel alignment condition of multiple rolls in applications such as paper and printing machines and rolling mills, even when line of sight to or between rollers is not possible. Measurement is accurate to microns and can be achieved in quick time for example 15 rolls in as little as 30 minutes.



### **HYDRALIGN® new in 2010**

Is an online monitoring system based on the measurement principle of a water level. The hydrostatic measurement system has various application areas and is especially suitable for long term monitoring of plants and machine foundations as well as monitoring of building settlements. The pressure sensors are permanently installed on the machine foundations to measure height changes exactly.

# **Glossary of Pruftechnik products**

---



# Glossary of Pruftechnik products

## Condition Monitoring hand portable systems

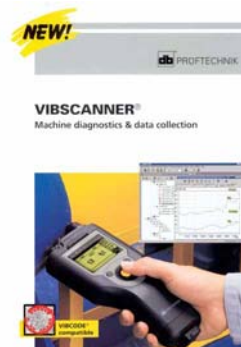

**VIBSCANNER®** is a multifunction condition monitoring system and data collector for rotating machine FFT vibration analysis, bearing condition measurement, balancing and trending. Using built in or external sensors the system measures vibration, temperature, RPM and other process parameters. *The system is available ATEX approved intrinsically safe to EEx ib IIc T4.*



**VIBROTIP®** is the ideal multifunction data collector for monitoring of rotating machine condition. Built in sensors allow for measurement of Vibration, pump cavitation, temperature and RPM. Clear on screen graphics and user friendly operation makes this tool the ideal starter device for basic plant condition monitoring.



**VIBXPERT II®** is a fully featured 2 channel condition monitoring system for advanced data collection and FFT analysis. Its large high resolution colour display massive onboard memory, simple navigation, knowledge based set ups for easy user interface. The system measures and records all forms of machine vibrations, bearing condition, as well as process and inspection data and is compatible with almost any type of vibration transducer.

*All Pruftechnik Portable CM systems operate with the VIBCODE fingerprinted data collection system, and the common software platform OMNITREND, for seamless upgrade as CM requirements grow.*

# Glossary of Pruftechnik products

## Condition Monitoring hard wired systems



**VIBRONET® Sign@lmaster** is a modular on line system that provides comprehensive data on rotating machine operating condition. Features such as on line trending FFT analysis, are supported by Omnitrend software plus HTML interface for remote monitoring and analysis from any location world wide. The system even provides alarm reporting via SMS. *The system is available ATEX intrinsically safe to EEx ib IIc T4.*



**VIBROWEB® XP** is an intellegent machine monitoring system which can perform measurements, evaluation saving and alarm warnings independantly even without a PC connection. The system has been developed for production critical or process critical machines which require optimised monitoring routines and diagnostic procededures at a low investment cost.

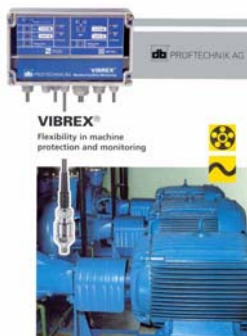

**VIBREX®** is a one or two channel on line system for monitoring viration or bearing comndition in remote locations. Built in alarm settings allow the user to provide system protection via 4 - 20 mAmp outputs to PLC systems or other alarm recording devices. Vibrex is a cheap but cost effective system for users with only one or two critical machines to monitor on line. *The system is available ATEX intrinsically safe to EEx ib IIc T4.*

# Glossary of Pruftechnik products

## Bearing Fitting system



**EDDYTHERM®** Induction heaters are the ideal way to shrink fit bearings and other circular metal components such as gears or wheels to shafts. Induction heating provides controlled heating where only the component to be heated gets hot. Microprocessor control determines the heating profile and ensures even temperature stability across the whole component

## Pulley Alignment system



**PULLALIGN®** is a laser alignment system for the accurate alignment of pulley, belt and chain drives. Using the Pruftechnik patented reflected beam system corrections for vertical and horizontal angularity and offset are corrected with just two machine moves all whilst the operator views the alignment corrections as they occur.

## Maintenance products Catalogue



**Pruftechnik Direct** is a unique maintenance catalogue for maintenance engineers who need to source tools for day to day maintenance tasks. A whole range of gas detectors, laser systems, temperature monitoring devices and other key tools are available from one source. Alternatively the on line web site [www.pruftechnikdirect.com](http://www.pruftechnikdirect.com) provides instant access to the whole product range.

## PRUFTECHNIK Alignment and Condition Monitoring Service

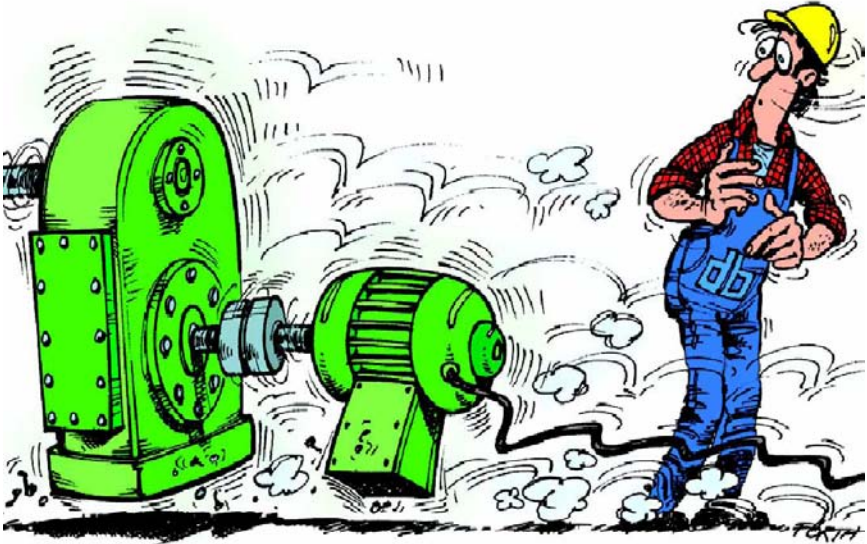

Process industry world wide is striving for ever increasing reductions in production costs. To remain competitive no avenue of potential saving can be ignored. Plant maintenance is no exception, it is accepted as an essential component in any process company, but is also a cost that managers are keenly aware is an overhead that they cannot really afford. As far back as 1988 a DTI report on UK manufacturing industry concluded that some £14 Billion was spent annually by industry on maintaining its process plant. Money that was a necessary but an inevitable drain on the ability of UK industry to be competitive with emerging industrial economies.

To keep your plant operating efficiently and safely we provide an unrivalled range of specialist services to UK industry including.

**Roll parallelism measurement** - using a unique system PARALIGN we are able to measure the parallelism of rolls with high accuracy and speed.

**Turbine alignment** - using the patented CENTRALIGN system we can measure machine bore concentricity, turbine diaphragms and bearing pockets without the need for wires or dummy shafts.

---

**Rotating machine shaft alignment** - complex machine alignment is a speciality, using the industry standard system NOVALIGN we can measure shaft alignment on single or multiple machine trains of any configuration and size - even in intrinsically safe environments.

**FFT analysis** of machine operating condition, using the VIBXPERT and VIBSCANNER systems we can quickly identify and report incipient machine problems and running condition.

**Dynamic Balancing** in one or two planes on simple or complex rotating machine systems.

**One-line machine condition monitoring** and analysis using VIBROWEB technology keeps the health of critical machines safely monitored



## Further Reading

---

### Shaft Alignment

- Shaft Alignment Handbook - second edition John Piotrowski  
ISBN 0-8247-9666-7
- Maintenance Fundamentals - Keith Mobley  
ISBN 0-7506-7151-3
- Rotalign Pro user handbook - Pruftechnik Ag edition 2001
- Optalign - user handbook - Pruftechnik Ag edition 1991
- smartALIGN user handbook - Pruftechnik Ag edition 2002
- Introduction to machinery analysis - John Mitchell 1993  
ISBN 0-87814-401-3
- Infrared Thermography and Laser alignment technologies. - 1994 Infrasppection Institute  
Frank Pray and Bruce Bortnem.
- Drives and Seals - M J Neal  
ISBN 0 7506 0981 8

### Vibration Analysis

- The Vibration monitoring Handbook - Coxmoor publishing  
ISBN 1 90189 200 X
- International conference on condition monitoring - Coxmore publishing  
ISBN 1 90189 214 X
- Management guide to condition monitoring in manufacture - Institute of Production engineers  
ISBN 0 85510 037 0
- Vibscanner user handbook - Pruftechnik Ag edition 2002
- Vibration Spectrum analysis - Steve Goodman  
ISBN 08311 30881 2nd Ed

### Dynamic Balancing

- Dynamic Balancing of rotating machinery - J B Wlicox  
ISBN 02734 2959 0
- Machinery Vibration Balancing - Victor Wowk  
ISBN 00707 1938 1
- Vibration Manual - Pruftechnik Ag edition 1985

## **Further Reading**

---

Balancing accuracy of rigid rotors - Dott.Ing Luigi Buzzi, booklet  
No8 -III edition 1989  
(translated by P F Kercher)

### **ISO Standards**

Mechanical vibration - Evaluation of machine vibration by measurements on non-rotating parts ISO 10816 - 3

Field balancing equipment - Description and evaluation ISO 2371

Balancing quality of rotating rigid bodies ISO 1940.-1973











---

**Productive maintenance technology**

PRÜFTECHNIK  
Condition Monitoring  
Oskar-Messter-Str. 19-21  
85737 Ismaning, Germany  
Tel: +49 89 99616-0  
Fax: +49 89 99616-300  
eMail: [info@pruftechnik.com](mailto:info@pruftechnik.com)  
[www.pruftechnik.com](http://www.pruftechnik.com)

A member of the PRUFTECHNIK group